

EUROTRANS: European Research Programme for the Transmutation of High-Level Nuclear Waste in an Accelerator Driven System

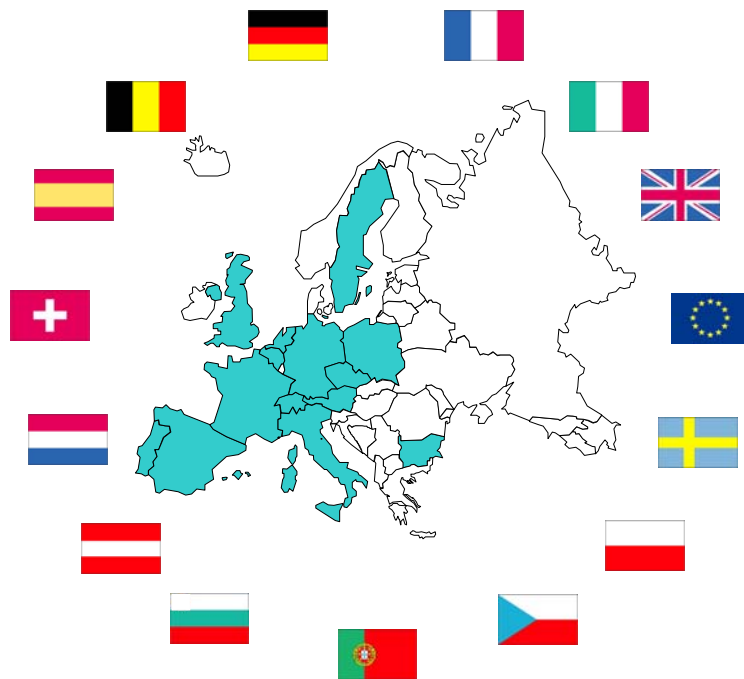

**9 IEMPT Nîmes
September 25-29 2006**

**Joachim U. Knebel, Co-ordinator
and EUROTRANS Team**

The EUROTRANS Consortium



Framework and Strategy of P&T

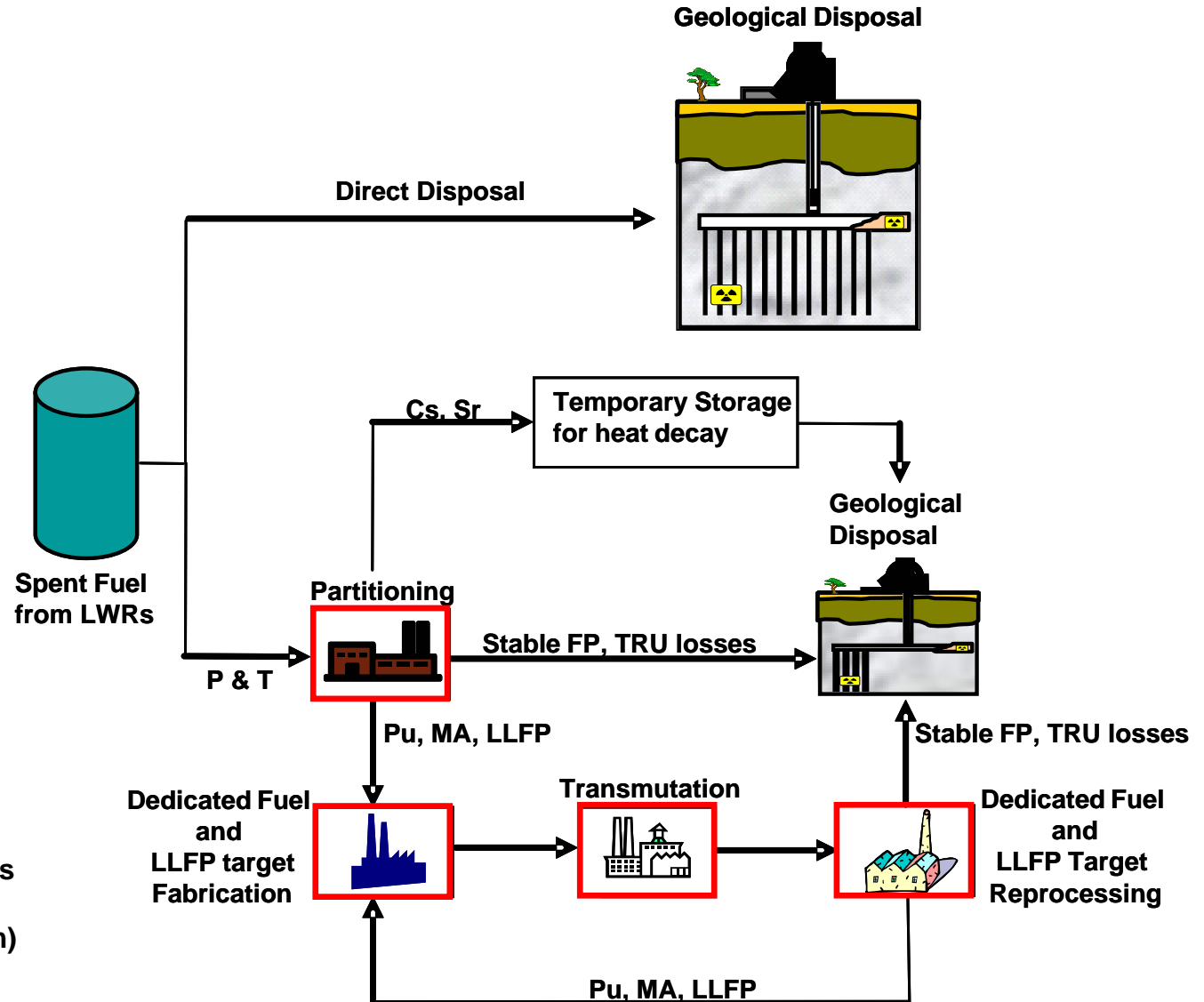

LLFP: Long lived fission products (Tc-99, I-129, Se-79, ...)
 MA: Minor Actinides (Am, Np, Cm)

Framework and Strategy of P&T

- **The implementation of P&T of a large part of the high-level nuclear wastes in Europe needs the demonstration of its feasibility at an “engineering” level. The respective R&D activities could be arranged in four “building blocks”:**
 - **Demonstration of the capability to process a sizable amount of spent fuel from commercial LWRs in order to separate plutonium (Pu), uranium (U) and minor actinides (MA),**
 - **Demonstration of the capability to fabricate at a semi-industrial level the dedicated fuel needed to load in a dedicated transmuter,**
 - **Design and construction of one or more dedicated transmuters,**
 - **Provision of a specific installation for processing of the dedicated fuel unloaded from the transmuter, which can be of a different type than the one used to process the original spent fuel unloaded from the commercial power plants, together with the fabrication of new dedicated fuel.**

Roadmap for ADS Development

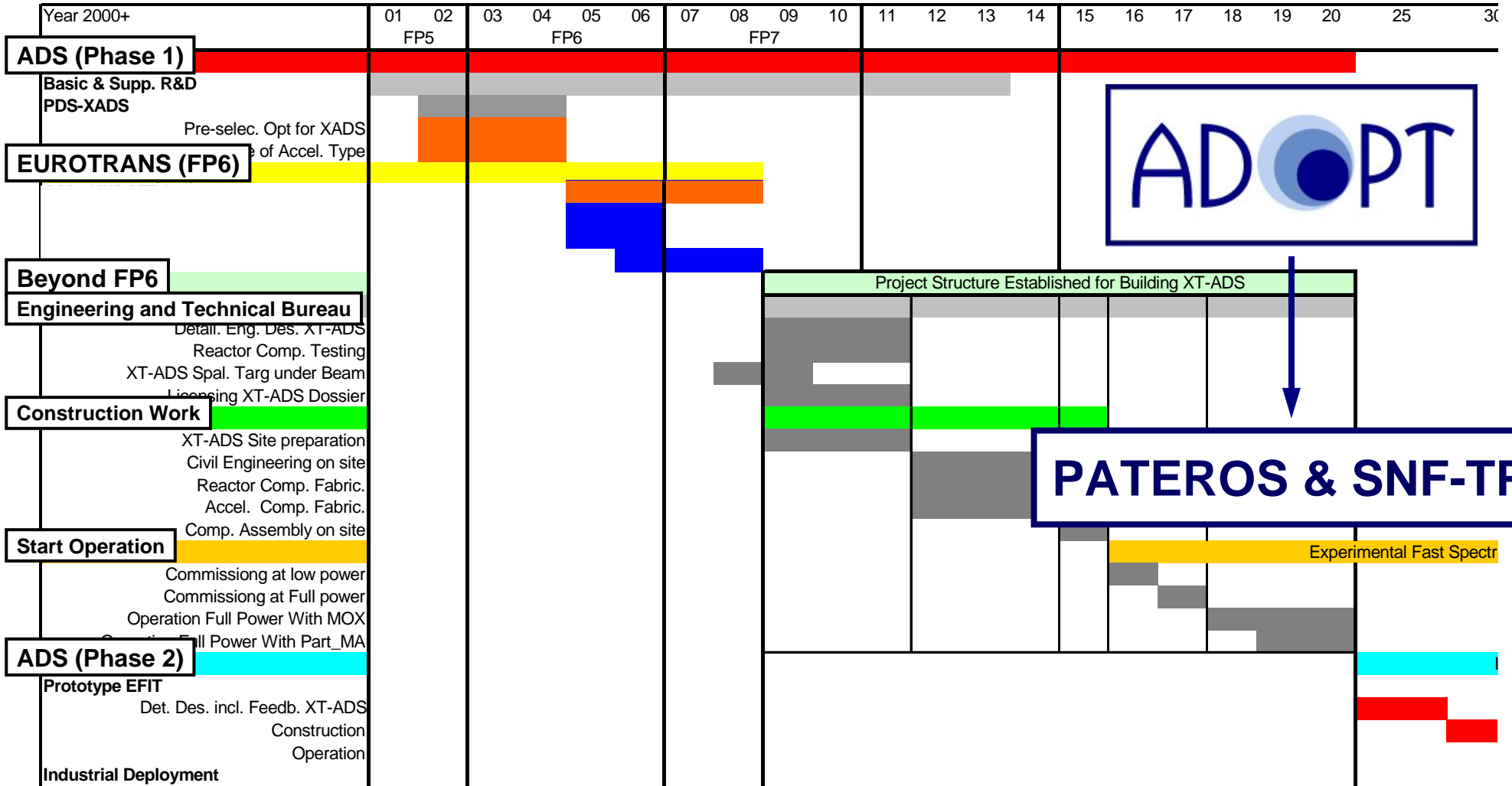

Overview: Objectives of IP

- Carry out a first advanced design of a 50 to 100 MWth eXperimental facility (realisation in a short-term, say about 10 years) demonstrating the technical feasibility of Transmutation in an Accelerator Driven System (**XT-ADS**), as well as to accomplish a generic conceptual design (several 100 MWth) of the European Facility for Industrial Transmutation **EFIT** (realisation in the long-term). This step-wise approach is termed as European Transmutation Demonstration (**ETD**) approach,
- For the above devices, provide validated experimental input (such as experimental techniques, dynamics, feedback effects, shielding, safety and licensing issues) from relevant experiments at sufficient power (20-100 kW) on the **coupling** of an accelerator, a spallation target and a sub-critical blanket,
- to develop and demonstrate the necessary associated **technologies**, especially accelerator components, fuels development, heavy liquid metal technologies, and the required nuclear data,
- to prove its **overall technical feasibility**, and
- to carry out an **economic assessment** of the whole system.
- ➔ **Direct input to PATEROS and SNF-TP.**

Strategy of EUROTRANS

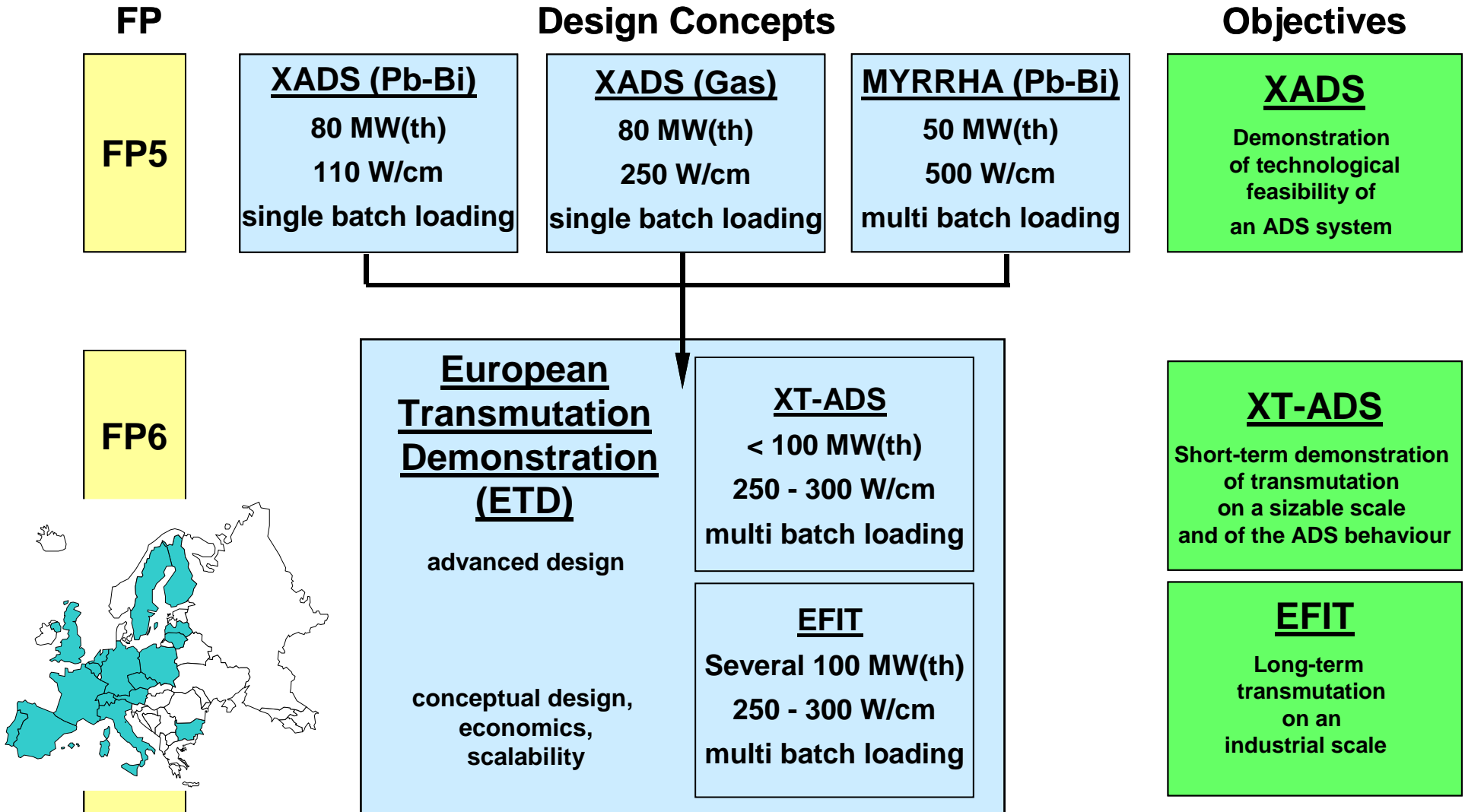

Structure of EUROTRANS

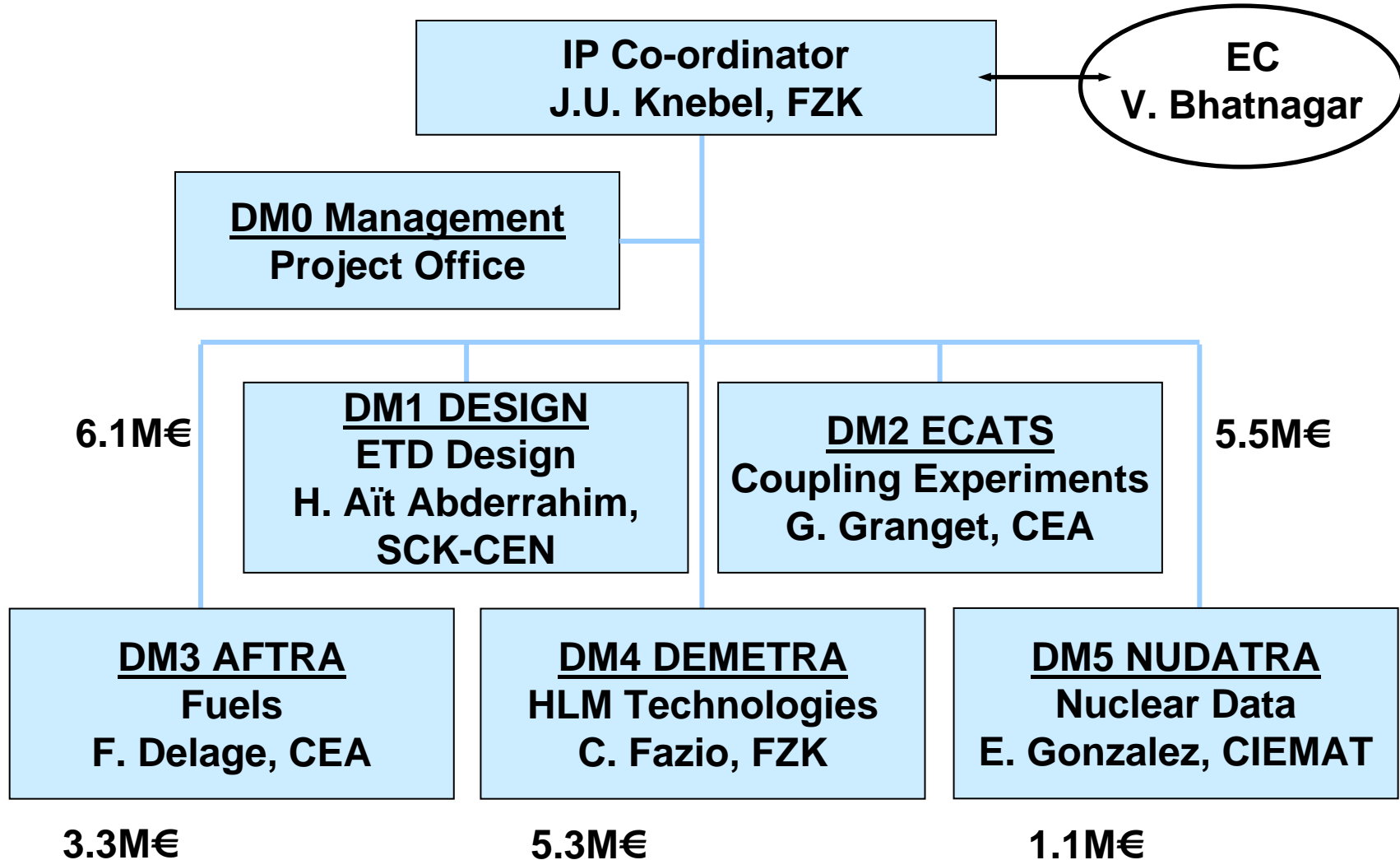

DM1 DESIGN: Objectives

- To carry out a **detailed design of an experimental ADS called XT-ADS** that construction can be started within the next 8 years.
- The XT-ADS should be as much as possible serving as a **technological test bench** of the main components of an industrial scale transmutation facility called EFIT
- To carry out a **conceptual design of the industrial scale ADS Pb cooled EFIT** and a gas cooled back up option of EFIT
- To **develop, construct and test the key components of the LINAC technology** that will be serving for XT-ADS as well as for EFIT. The driving parameter in this work is the improvement of the beam reliability
- To **design the windowless spallation target** module of the XT-ADS in terms of thermo-mechanical, thermal-hydraulic and vacuum
- To reassess the **global safety approach for ADS** in presence of MA fuel and apply it to the XT-ADS for assessment of DBC and DEC transients for preparing the SAR for the XT-ADS
- To assess the **investment and operational costs** of the XT-ADS and their scaling to EFIT and identify the needed R&D efforts

Major Results: DM1 DESIGN

- Rational definition of the design parameters for XT-ADS (being an ADS full demonstration, a fast spectrum irradiation facility and a test bench for EFIT); convergence for those of EFIT.
 - Accelerator components design and preparation for demonstration are progressing according to the planning.
 - Off-centre windowless target design is consolidated.
-
- Safety approach of FP5 XADS is updated to cope with presence of large amount of MA in the core of EFIT and high pressure water HX in the primary systems of both EFIT and XT-ADS.

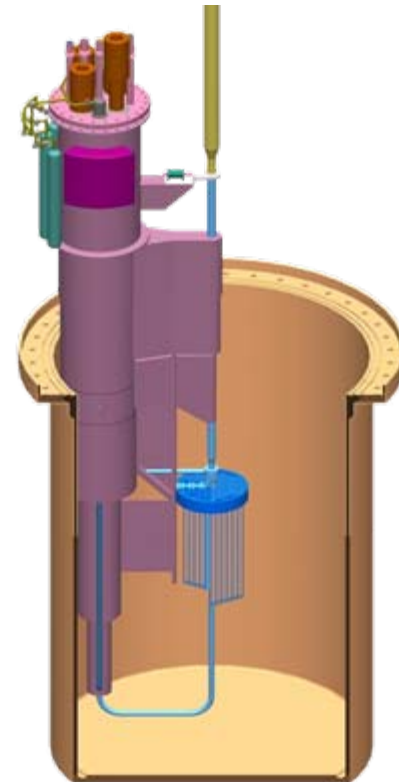

Preliminary Design Characteristics of the XT-ADS and EFIT Designs

	XT-ADS	EFIT
Proton energy	600 MeV x 2.5 mA / 350 MeV x 5 mA	800 MeV x 20 mA
Spallation target concept	Off-centered, windowless	Centered, windowless
Fuel	MOX, some minor actinide (MA) FA accepted	(Pu, AM)O ₂ + MgO (or metallic Mo) matrix
Power (MW _{th})	50 – 100	395
Power density (W/cm ³)	700	450 – 650
Reactivity swing compensation	no compensation as long as swing remains limited	the predicted small burn-up swing is to be compensated by proton current adjustment
Presence of absorbers	yes	for refueling only
Vessel structural material	316L	316 L
Vessel type	not yet defined	hung
Primary coolant	LBE	Pure Lead
Primary system temperature range (°C)	inlet: 300 outlet: 400	inlet: 400 outlet: 480
Secondary coolant	low pressure boiling water	Superheated water cycle
Fuel loading	from bottom (alternative from top has been reviewed)	from top
Fuel handling	oriented Remote Handling	extendible-arm handling machine and rotating plug
Seismic design	seismic spectrum specific to the Mol site	Horizontal anti-seismic supports

EFIT Conceptual Configuration

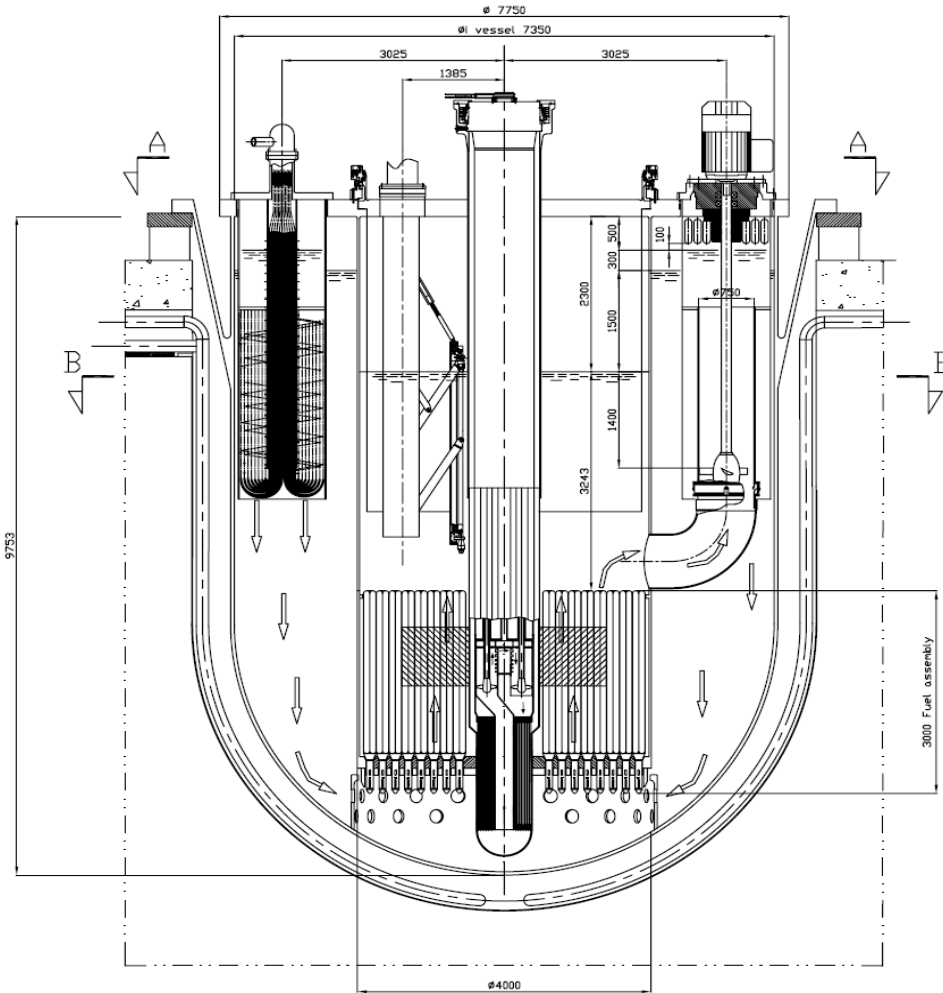

Basic Options chosen:

- **Reactor Vessel: cylindrical with hemispherical bottom head;**
- **General Arrangement: 4 PP (Primary Pumps), 8 SG (Steam Generators);**
- **Inner Vessel: cylindrical upstand, self-supported;**
- **Core support: Diagrid shaped as a thick disc welded to the Inner vessel, cylindrical shell welded to the bottom head as guide;**
- **Windowless Target Unit;**
- **Rotating plug coaxial to the core;**
- **Primary pump located in the hot leg;**
- **In-vessel fuel handling: one machine with extendible arm, on the rotating plug;**
- **DHR coolers: 4 in-vessel units;**
- **Lead purification: 2 in-vessel filter units.**

EFIT Conceptual Configuration

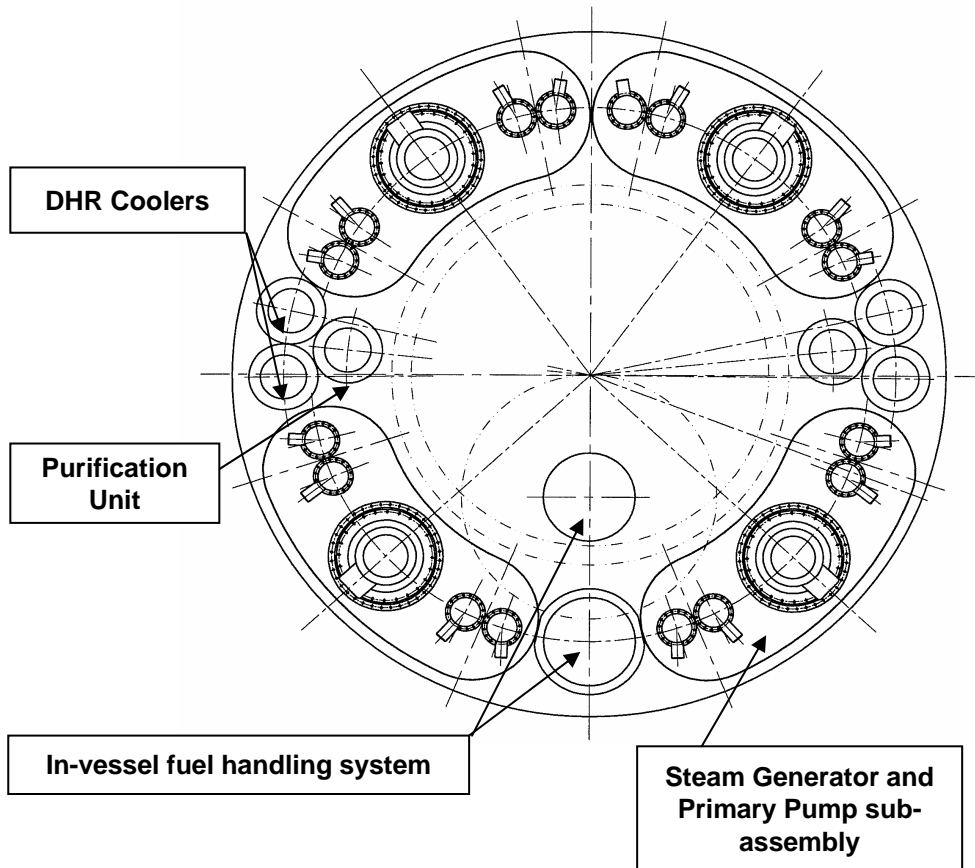

Basic Options chosen:

- **Reactor Vessel:** cylindrical with hemispherical bottom head;
- **General Arrangement:** 4 PP (Primary Pumps), 8 SG (Steam Generators);
- **Inner Vessel:** cylindrical upstand, self-supported;
- **Core support:** Diagrid shaped as a thick disc welded to the Inner vessel, cylindrical shell welded to the bottom head as guide;
- **Windowless Target Unit;**
- **Rotating plug** coaxial to the core;
- **Primary pump** located in the hot leg;
- **In-vessel fuel handling:** one machine with extendible arm, on the rotating plug;
- **DHR coolers:** 4 in-vessel units;
- **Lead purification:** 2 in-vessel filter units.

EFIT Fuel Assembly Outline Drawing

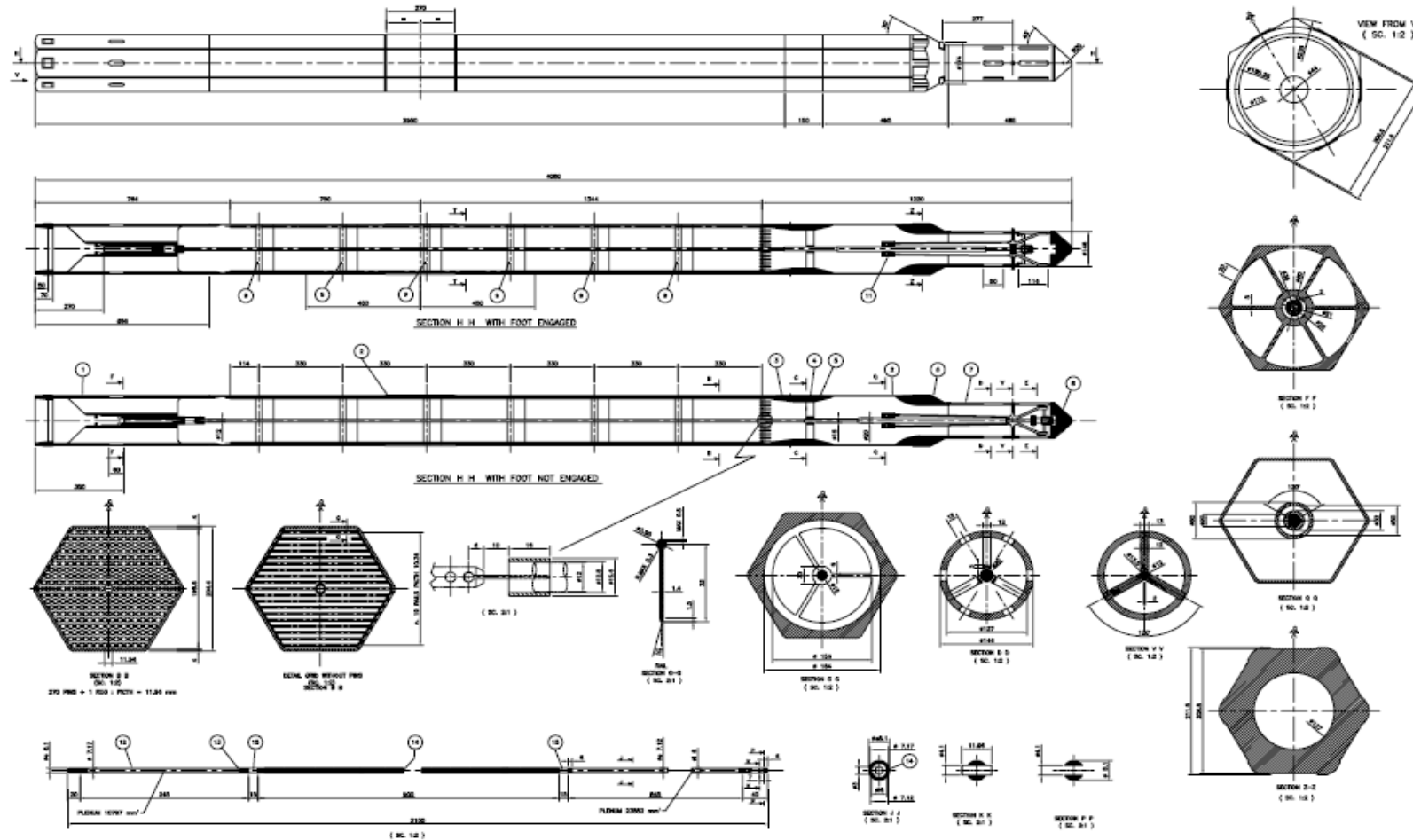

- Based on PDS-XADS design.
- LBE velocity below 2 m/s; $p/d \cong 1.4$.

XT-ADS Design Options

- MYRRHA like refuelling from below
- Refuelling from the top
- Vertical separation (Rectangular shape Inner Vessel with a lower cylinder containing the core)

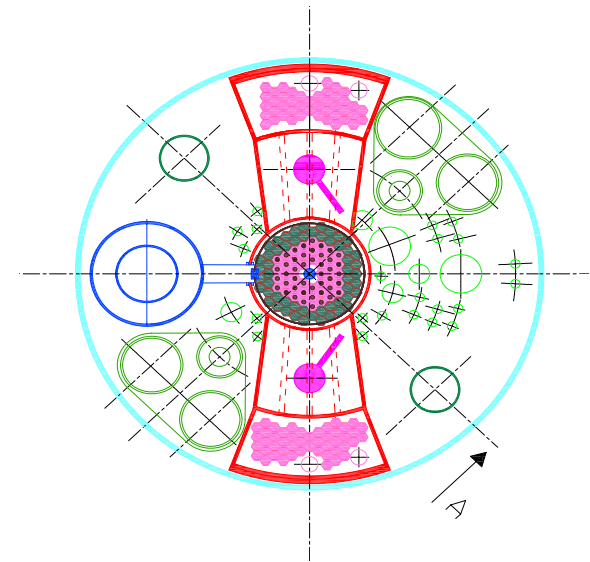
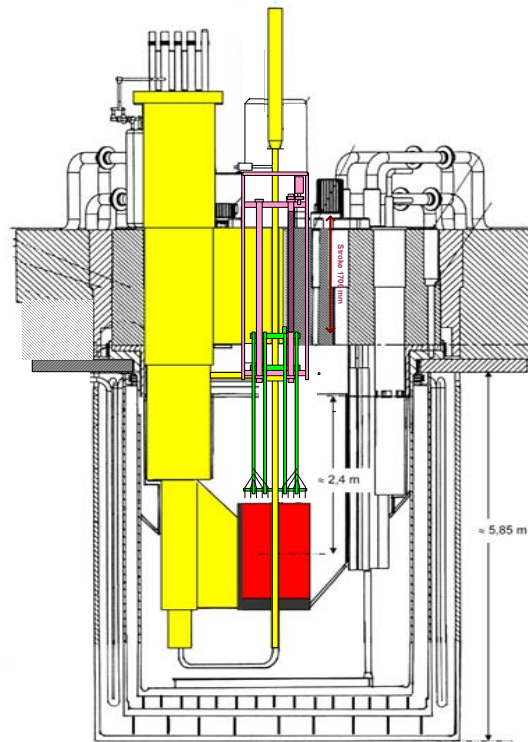
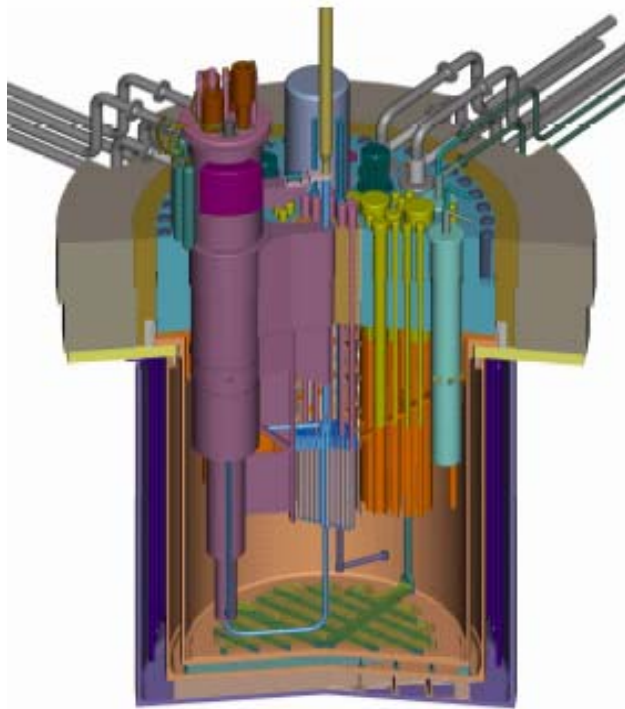

Study of the Accelerator with Special Focus on the Experimental Demonstration of the Required Reliability

Task 1.3.1	Task 1.3.2	Task 1.3.3	Task 1.3.4	Task 1.3.5
Experimental evaluation of the proton injector reliability	Assessment of the reliability performances of the intermediate energy accelerating components	Qualification of the reliability performances of a high energy cryomodule at full power and nominal temperature	Conceptual design of an RF control system for fault tolerant operation of the linear accelerator	Overall coherence of the accelerator design, final reliability analysis, cost estimation of XT-ADS and EFIT

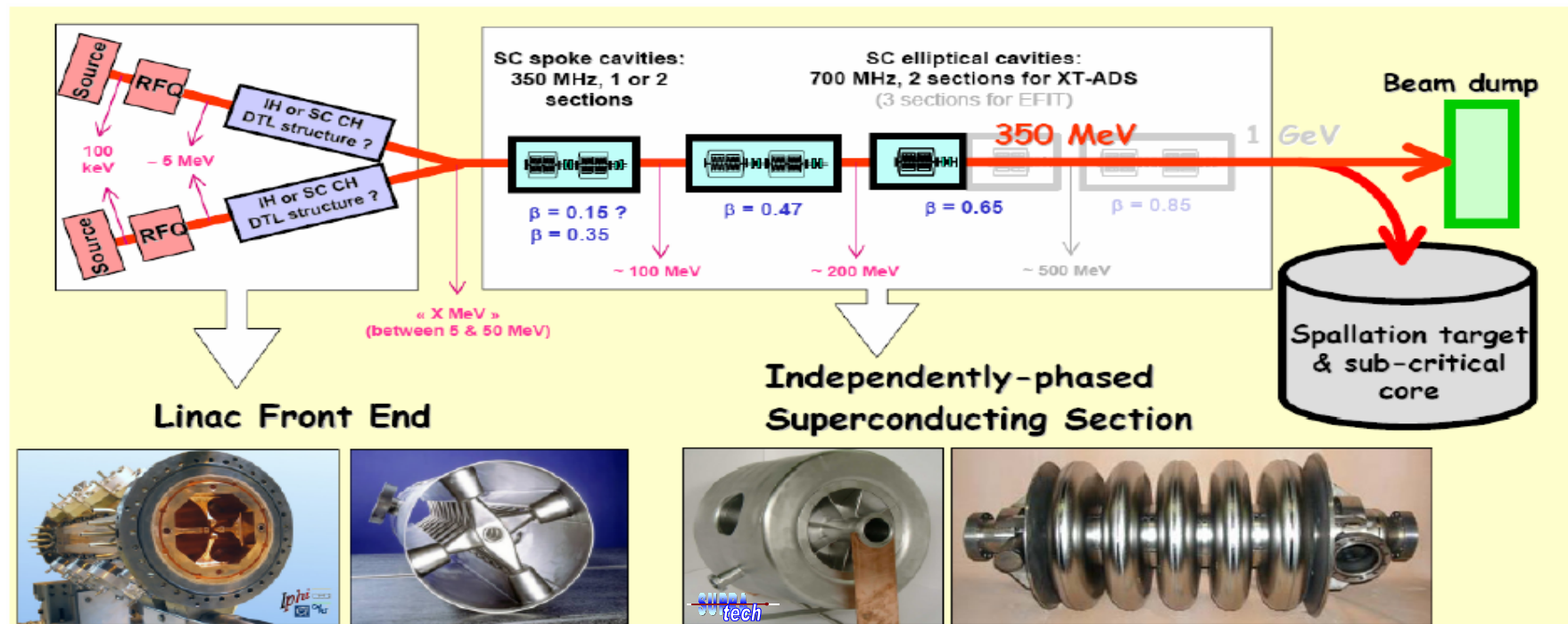

Status of Accelerator Work Packages

- **WP1.3.1:**
Construction of the 3 MeV – 100 mA IPHI linear injector accelerator in progress
Reliability test protocol for EUROTRANS under evaluation
- **WP1.3.2:**
Construction of horizontal cryostat for qualification of spoke cavity reliability in progress
CH-structure is built and tested in vertical configuration
- **WP1.3.3:**
Design of high-energy accelerating cryomodule has started, RF system hardware have been ordered
- **WP1.3.4:**
Modeling of the low level RF system for fault-tolerance in progress
- **WP1.3.5:**
Substantial work accomplished for beam optic in normal operation, simulation of accidental conditions advancing
Initial accelerator cost analysis completed
New beam line task will start soon

Spallation Target: Conceptual Properties

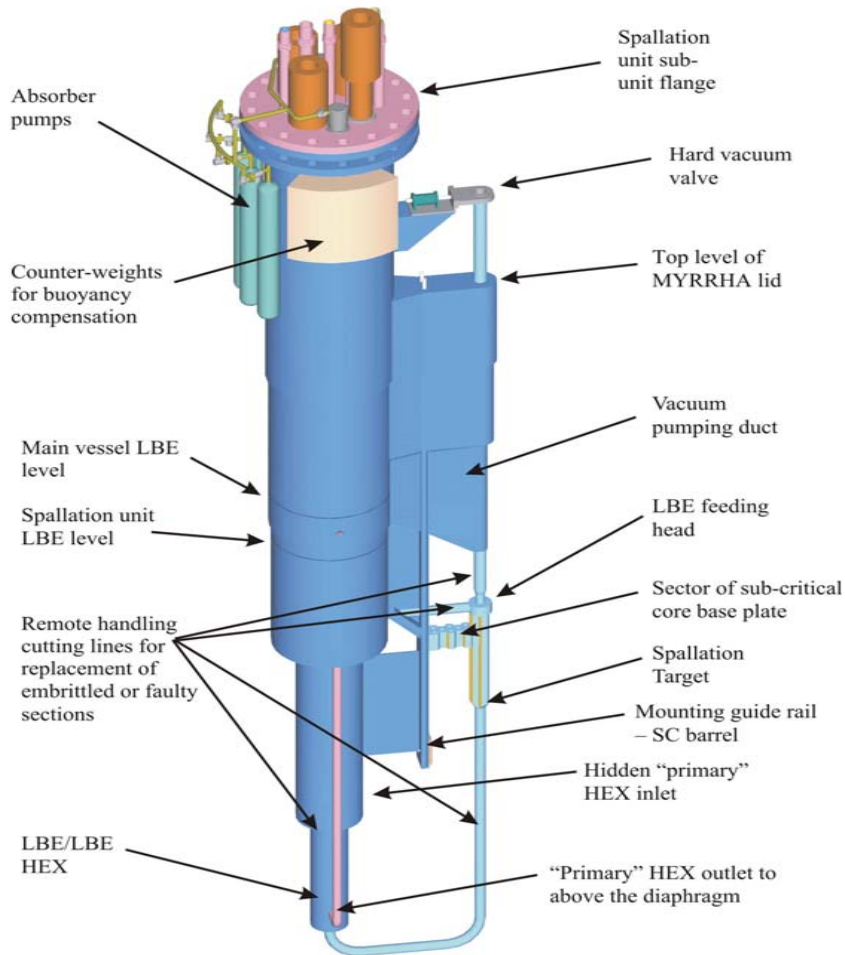

- **Windowless target**
 - Space considerations : $\phi 72$ mm target
 - 5 mA current or $125-175 \mu\text{A}/\text{cm}^2$
- **Vertical co-axial confluent LBE flow**
 - Free surface formation

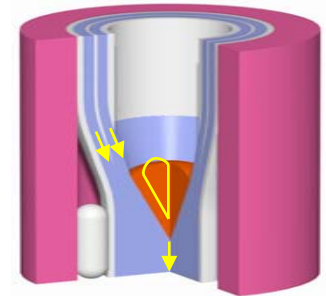

- **Off axis LBE servicing**
 - Target space
 - Pump & HEX below free surface
 - Leave top & bottom of subcritical core free \Rightarrow Accessibility
 - Spallation loop away from high dose zone \Rightarrow Lifetime

Spallation Target: Free Surface Formation

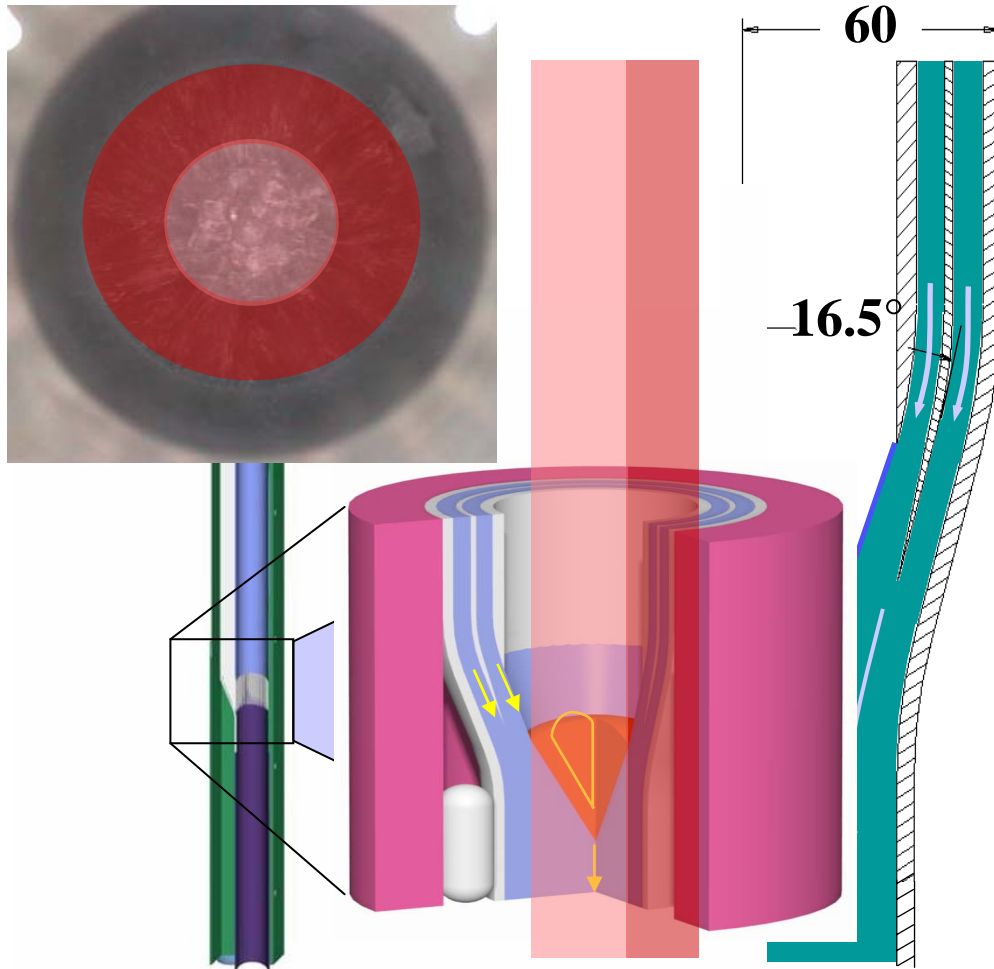

- Confluence of vertical co-axial flow
- Main flow: mechanical pump
- Driving force: gravity
- Level: balance inlet-outlet flow
- Recirculation zone: in check
 - Level balance $\Delta h_{\max} = 3 \text{ mm}$
- Feedback necessary:
 - LIDAR level detection
 - fast MHD pump
- Proton beam distribution:
 - Avoid recirculation zone heating

DM2 ECATS: Objectives

Objective:

- Assist the design of XT-ADS and EFIT, provide validated experimental input from relevant experiments at sufficient power (20-100 kW) on the **coupling of an accelerator, a spallation target and a sub-critical blanket.**

Input Data Base Validation Required:

- Qualification of **sub-criticality monitoring**,
- Validation of generic **dynamic behaviour of an ADS** in a wide range of sub-critical levels, sub-criticality safety margins and thermal feedback effects,
- Validation of the **core power / beam current** relationship,
- **Start-up and shut-down procedures**, instrumentation validation and specific dedicated experimentation,
- Interpretation and validation of experimental data, benchmarking and **code validation activities** etc.,
- **Safety and licensing issues** of different component parts as well as that of the integrated system as a whole.

ADS Validation Process

- Experimental Programme Matrix -

Validation of:	Full coupling of real ADS components	Physics and kinetics of an external source driven subcritical core at ~0 power	Dynamics and experimental techniques of an ADS at power with feedbacks	High energy neutrons propagation	Power/beam current relation validation	Operations at power (start-up / shutdown / scram)
TRADE	YES	YES	YES	NO	YES	YES
MUSE	NO	YES	NO	NO	NO	NO
RACE	NO	YES	YES	NO	YES	YES
SAD	YES	YES	NO (*)	YES	NO	NO
YALINA	NO	YES	NO	NO	YES	NO
GUINEVERE	NO	YES	NO (**)	NO	YES	YES

(*) YES, if power is extended to ~100kW

(**) YES, if higher power considered compared to today's proposal (to be assessed)

RACE-T: Objectives and Facility

Objective:

Qualification of methods for determination of reactivity and power distribution in sub-critical systems.

Experimental Facility :

TRIGA reactor in the ENEA Research Center, Cassacia, Italy

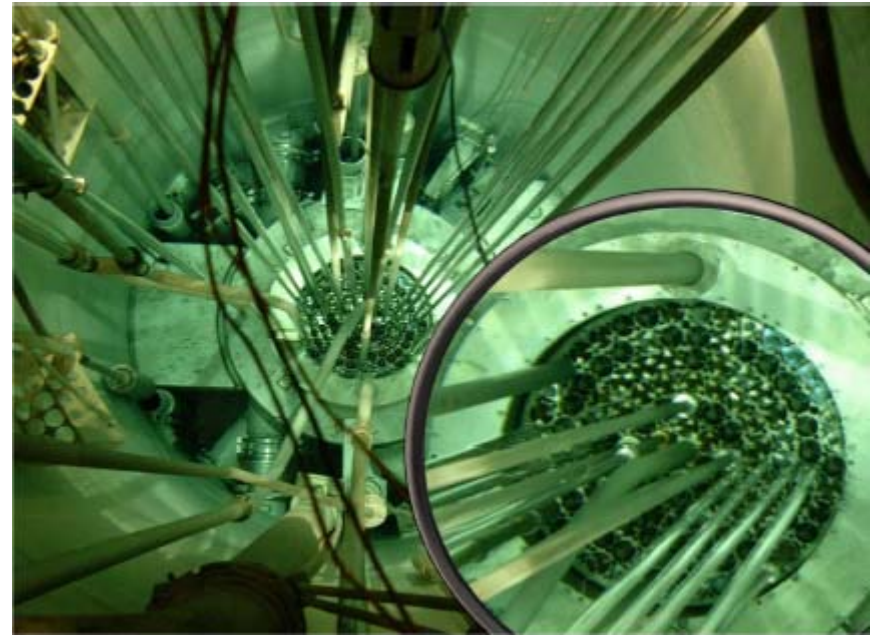

Reactivity Measurements

Three sub-critical core states investigated :

- SC0: $k = 0.997$;
- SC2: $k = 0.977$;
- SC3: $k = 0.959$

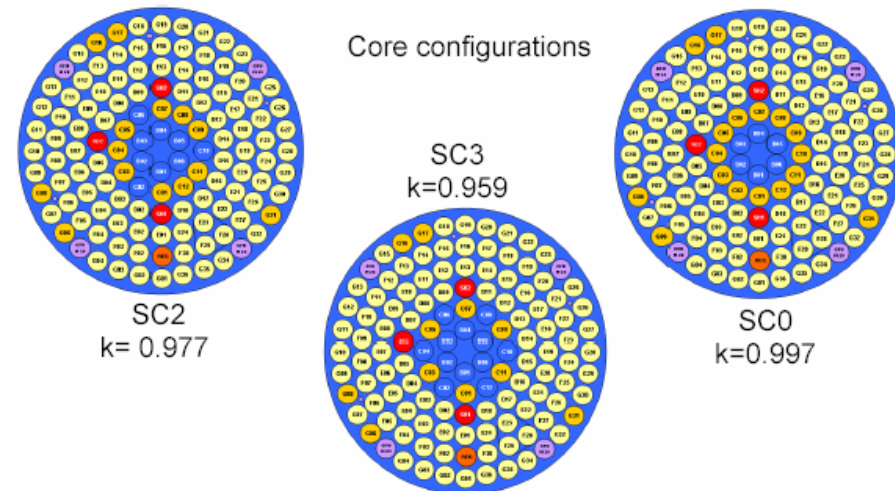

Different techniques for measurement of reactivity:

- Source Multiplication (critical reactor $k=1$ is used to calibrate reactivity)
- Rod-drop
- Source Jerk
- Pulsed Neutron Source (prompt decay analysis, prompt neutrons/delayed neutrons analysis by areas)

Reactivity Measurements

Three sub-critical core states investigated:

- SC0: $k = 0.997$;
- SC2: $k = 0.977$;
- SC3: $k = 0.959$

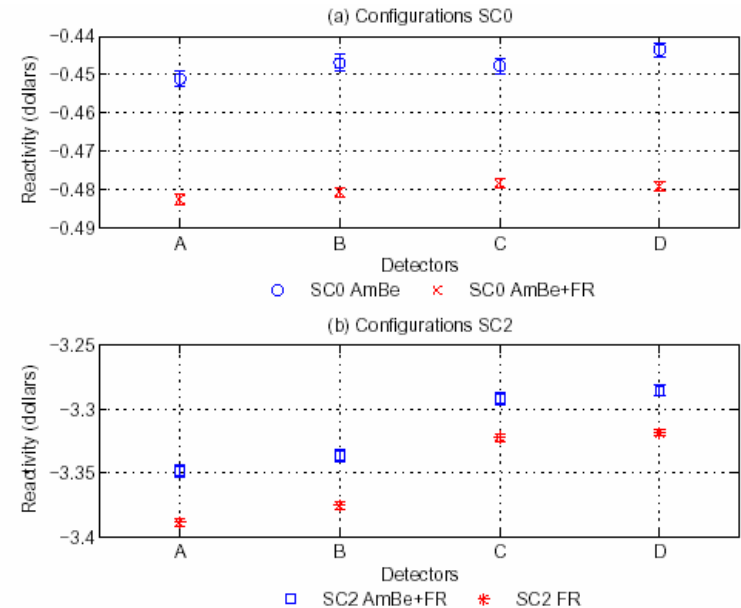

Different techniques for measurement of reactivity:

- Source Multiplication (critical reactor $k=1$ is used to calibrate reactivity)
- Rod-drop
- Source Jerk
- Pulsed Neutron Source (prompt decay analysis, prompt neutrons/delayed neutrons analysis by areas)

New Proposal: GUINEVERE

- Location: SCK-CEN Mol Belgium
- Coupling experiment of an upgraded version of the GENEPI accelerator (used in MUSE) to a fast spectrum core to be realised in the VENUS facility at SCK-CEN
- This European experiment will enable:
 - to complete the MUSE experiment
 - to perform a low-power coupling experiment with a continuous beam
 - to validate the current / power relationship
 - to investigate the physics of a fast spectrum core simulating Pb cooling
 - to address safety and licensing issues in front of the Belgium authorities that will eventually licence XT-ADS

VENUS and GENEPI Today

VENUS is a very flexible water moderated zero power facility

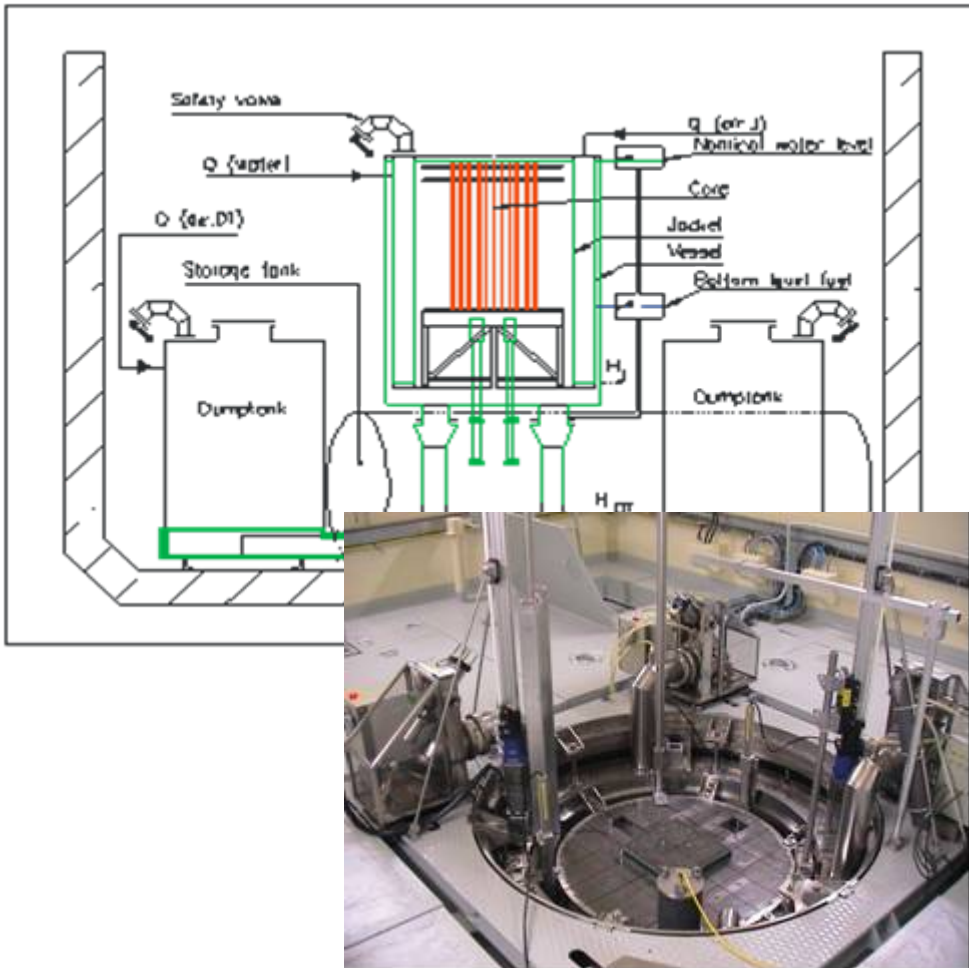

GENEPI is a pulsed neutron accelerator

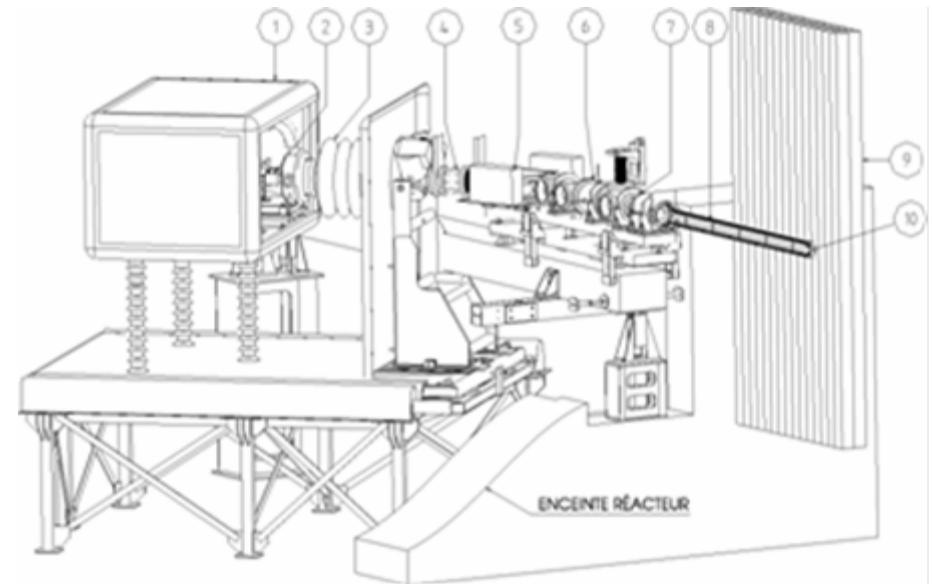

- 1) High Voltage Head,
- 2) duoplasmatron,
- 3) accelerator tube,
- 4) quad Q1,
- 5) magnet,

- 6) quad Q2,
- 7) quad Q3,
- 8) quad Q4 + T2 part,
- 9) MASURCA tube,
- 10) target

VENUS: Needed Modifications

- **Construction of additional accelerator building on top of reactor hall**
- **Installation of modified GENEPI accelerator**
- **To modify the water-moderated thermal reactor in a fast lead reactor, the following main items were identified:**
 - **A shut-down system based on shut-down rods will have to be developed.**
 - **Construction of fuel assemblies (lead + fuel rodlets) for the core and lead for the reflector**
 - **30% enriched metal U-fuel**
 - **Supporting structure to reinforce the structures to carry the lead**
 - **Adaptation fuel storage facilities**
 - **New exploitation procedures**

GENEPI: Needed Modifications

- **The duoplasmatron source used at the present time is designed for a pulsed use and has to be changed to work in continuous mode.**
- **Beam interruption operation will have to be implemented: it could be performed by driving the source itself (if possible it is the easiest), or by a fast electrical deflexion downstream on the beam line (chopping).**
- **The focusing structure has to be checked for the whole intensity range required now (intense for pulsed mode and less intense in continuous mode). Some modifications might be necessary.**
- **The monitoring and control system of GENEPI 1-2 is performed by a PC computer and electronics which are based on out of date items (dates from 1998). A completely new system based on modern components and techniques has to be studied.**

DM3 AFTRA: Nuclear Fuel Development

Objective: Design, qualification and development of TRU-fuel for EFIT

Innovation: U-free oxide fuels + high MA content + Pb cooling

Issues:

- Fuel property data are sparse
- Fuel behaviour under irradiation is unknown
- ⇒ Fuel modelling is not qualified

AFTRA technical work:

- TRU-fuel design and performance assessment (modelling)
- Fuel safety assessment (modelling)
- Irradiation tests (on Am-based fuels)
- Out-of-pile property measurements (on Am-based fuels)

Fuel selection: (from FP5 FUTURE and CONFIRM)

- Oxide composite: $(\text{Pu}, \text{MA}, \text{Zr})\text{O}_2$; $(\text{Pu}, \text{MA})\text{O}_2 + \text{MgO}$ or Mo
- Backup solution: Nitride inert matrix fuel: $(\text{Pu}, \text{MA}, \text{Zr})\text{N}$

EFIT Fuel Pre-design, Performance, Safety

- A screening study based on physical and chemical criteria has lead to a preliminary recommendation for fuels: (MAsOx–MgO) and (MAsOx-⁹²Mo) composites
- A first performance and safety evaluation has been performed:

Criterion	MgO Matrix Fuel	Mo-92 Matrix Fuel
Transmutation capability	+	-
Price	+	-
Reactivity Loss	+	-
Irradiation Performance	-	?
High Temperature Stability	-	+
Margin-to-Failure	-	+
Safety Related Neutronic Data :		
Coolant Void	-	+
Clad Worth	-	+
Fuel Expansion Coefficients	+	+
Overpower Transients	-	+
Power/flow Mismatch Transients	-	+

- ✓ Best transmutation rate for MgO-Cercher fuel
- ✓ Best margins to failure for Mo-Cermet fuel

⇒ Perspective: core optimisation calculations as for transmutation efficiency, neutronic & thermal-hydraulic characteristics, safety behaviour.

In-pile Behaviour of MA Fuels

➤ **FUTURIX-FTA (PHENIX – June 07) :**

Irradiation of fuel candidates in EFIT (T and fast neutrons) representative conditions, to qualify and validate thermo-mechanical models for performance prediction.

(Pu, Am)O₂+MgO, He bond (Pu, Am)O₂+⁹²Mo, He bond

(Pu, Am, Zr)O₂+⁹²Mo, He bond (Pu, Am, Zr)N, Na bond Pu-Am-Zr, Na bond

➤ **HELIOS (HFR – March 07) :**

Irradiation of fuel candidates to gain knowledge of the T and the microstructure on He release and fuel behaviour.

(Am₂Zr₂O₇)+MgO (Am,Zr,Y)O₂ (Pu,Am,Zr,Y)O₂

(Am,Zr,Y)O₂ +⁹²Mo (Pu,Am)O₂+⁹²Mo

➤ **BODEX (HFR – Oct.06) :**

Irradiation of ¹⁰B (surrogate of ²⁴¹Am) doped inert matrices to model the helium release.

(Y,Zr)O₂ MgO Mo

DM4 DEMETRA: Objectives

- Improvement and assessment of the Heavy Liquid Metal (HLM) **technologies and thermal-hydraulics** for application in ADS, where the HLM is both the spallation material and the primary coolant.
- Characterisation of the reference **structural materials** in representative conditions (with and without irradiation environment) in order to provide the data base needed for design purposes, e.g. fuel cladding, in-vessel components, primary vessel, instrumentation, spallation target with/w'out beam window.
- **Challenges:**
 - Irradiation experiments in HLM
 - Large scale thermal-hydraulics tests
 - Long-term corrosion tests and mechanical tests in HLM
 - Free surface characterisation
- **Reference Materials:**
 - T91 steel for the highly loaded parts (e.g. cladding)
 - AISI 316L less demanding conditions (e.g. vessel)
 - Fe/Al coatings as corrosion protection barrier

Corrosion Mechanisms and Test Matrix

→ Whatever the protection method is, an adequate OCS is needed!

Protection system	Oxide protection	Transition zone	FeAl based coatings protection
Corrosion mechanism	Oxide formation on martensite and austenite	Oxide formation on martensite	oxide layers unstable
		Mixed corrosion mechanism : oxidation / dissolution on austenite	FeAl based coating stable
		500 °C	550 °C

→ Test Matrix

Objectives	Experimental activities in LBE				
	Loop	T _{exp} °C	ΔT K	Flow rate m/s	Oxygen in LBE wt.-%
Materials: - Long-term corrosion, modelling - high temperature corrosion barrier development (GESA)	CORRIDA (FZK)	550	150	2	10 ⁻⁶
	CICLAD (CEA)	550	-	1-5	10 ⁻⁶
	COLONRI (NRI)	550	50-150	<< 1	10 ⁻⁵ -10 ⁻⁸ Abnormal conditions
	CU2 (IPPE/FZK)	500, 550, 600	< 250	1.3	10 ⁻⁶
	LECOR (ENEA)	450	100	1	Low oxygen Windowless concept
	LINCE (CIEMAT)	450	150	1	10 ⁻⁶
Support the EFIT design	Experimental activities in Pb				
	Loop	T _{exp}	ΔT	Flow rate	Oxygen in LBE
	CHEOPE III (ENEA)	500	150	1	10 ⁻⁶
Basic studies	Testing in static conditions: welds, simulation of hot-spot and loss of O ₂ , investigation on the surface conditions effects				

Mechanical Properties: LCF and DBTT

→ Low cycle fatigue test in air and LBE: with / without GESA.

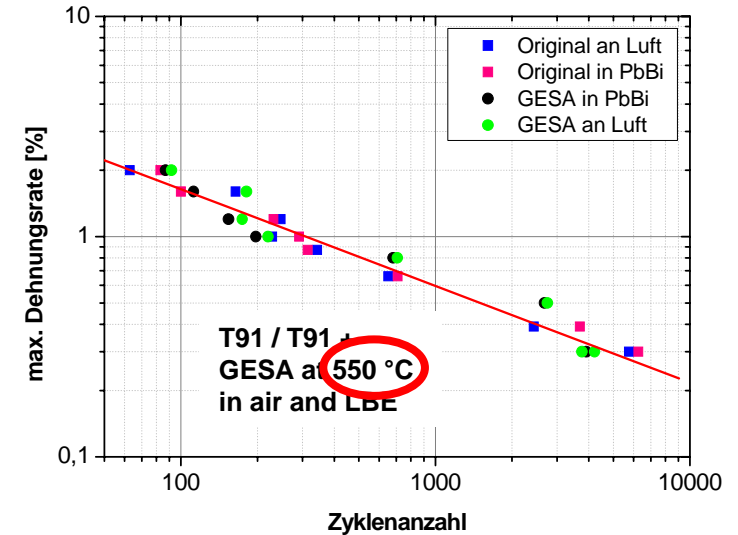
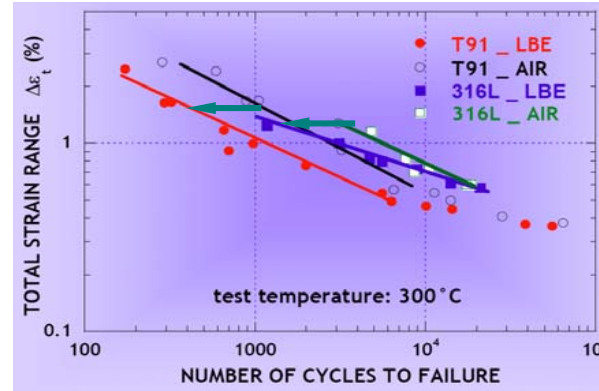

→ Ductile to Brittle Transition Temperature: Transition temperature increases and upper shell energy decreases with increasing radiation damage.

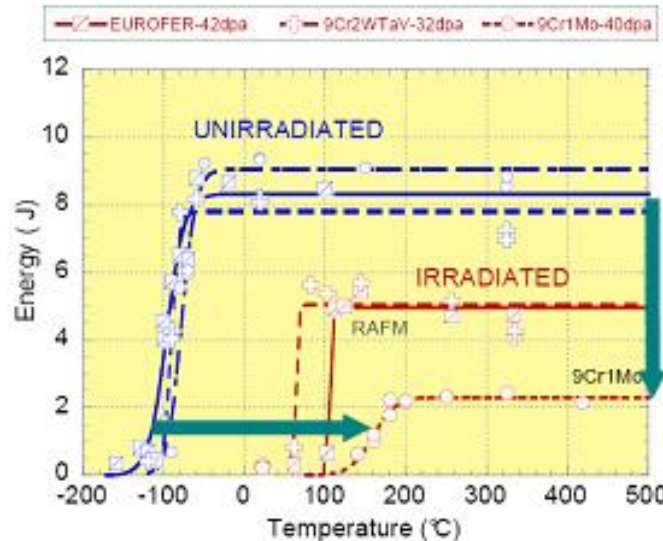

Neutron Irradiation: BOR 60 up to 325°C and 42 dpa

Thermal-hydraulics for Windowless Spallation Target

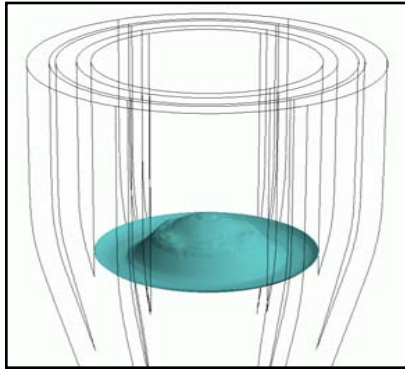

Free surface modelling



Free surface water experiments
UCL

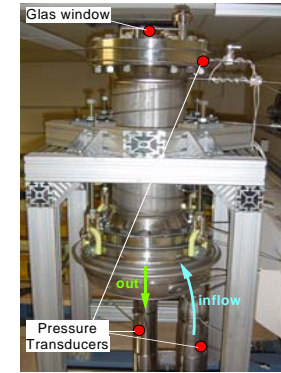

Free surface experiment in
LBE, FZK

Thermal-hydraulics for Core



Single Pin experiment
Tall, KTH



Fuel rod bundle experiment
THEADES, FZK



Integral experiment
CIRCE, ENEA

Window Target Configuration: MEGAPIE

MEGAPIE Experiment is successfully operating!!

Normal user operation was started on August 21st around 8:30 and is planned to continue until the normal annual winter shut-down starting on December 23rd 2006.

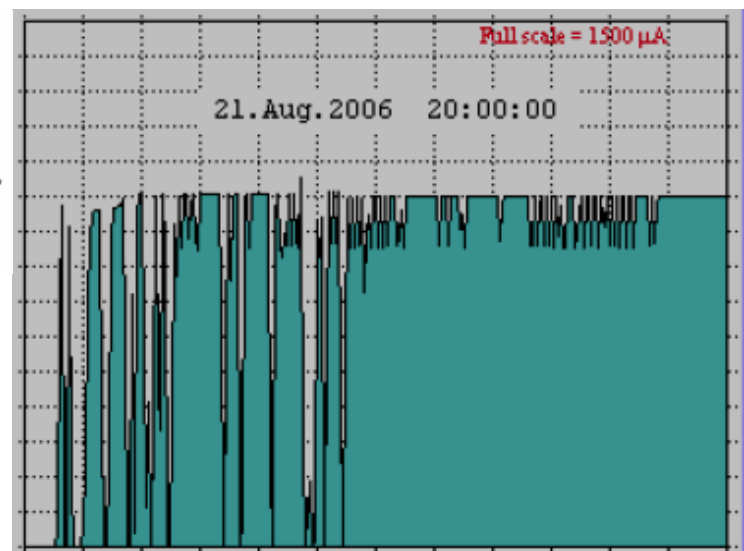

- Post Test Analysis gives unique opportunity to:
 - Validate neutronic and thermal-hydraulics predictions.
 - Assess component performance, as e.g the EMPS after irradiation.

DM5 NUDATRA: Objectives

- Improvement and assessment of the **simulation tools and associated uncertainties** for an ADS dedicated transmuter and its associated fuel cycle.
- The activity is essentially focussed on the **evaluated nuclear data libraries and reaction models** for materials in transmutation fuels, coolants, spallation targets, internal structures, and reactor and accelerator shielding, relevant for the design and optimisation of the EFIT and XT-ADS.



Gelina @ Geel
(UE-Belgium)



Cyclotron @ Uppsala
(Sweden)

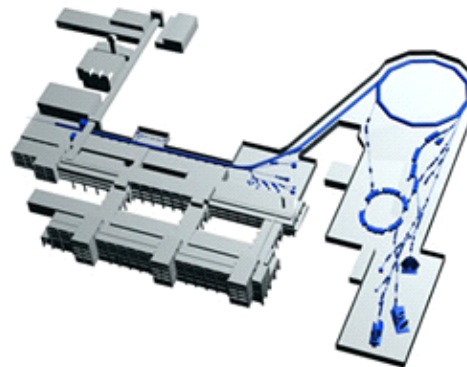

GSI @ Darmstadt (Germany)

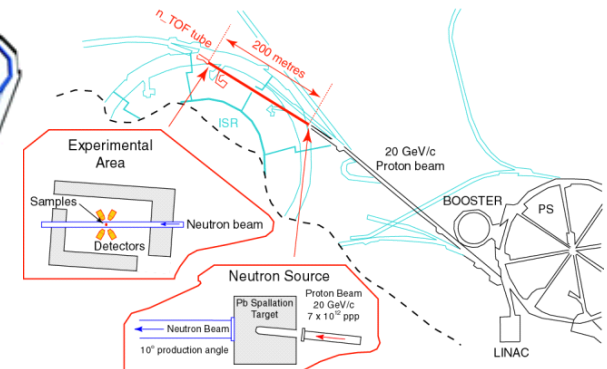

nTOF @ CERN (Switzerland)
and its TAS γ -calorimeter

Education and Training

- **Internal Training Courses (ITC) for PhD students and postdocs (“doctoral school”), organised by ENEN.**
 - **2 courses for each Domain = 10 in total**
 - **Participation: designed for 20 students**
 - **Duration: 4 days (from Wednesday to Saturday)**
 - **Lecturers: external and internal**
- **Opportunity to learn from experts and share the recently developed knowledge.**
- **Enlargement of the scope of the individual researchers to the scope of all five Domains of EUROTRANS.**
- **Opportunity for researchers involved in EUROPART and RED-IMPACT to learn from and exchange experience with EUROTRANS researchers.**

Internal Training Courses (ITC)

ITC	Year	Month	Topic	Host
1	1	3	ADS: objectives, context, concepts, challenges (scientific and technical)	KTH October 4-8 2005
2	1	9	Nuclear data for transmutation: status, needs and methods	USDC June 7-10 2006
3	2	12	ADS thermal-hydraulics: system codes and CFD codes, models and experimental validation	UCL December 6-9 2006
3	2	16	Accelerators and beam lines design	IAP-FU
5	2	20	Fuels and reactor structural materials	CIRTEN
6	3	26	Core design and reactor safety analysis	UPM-UNED
7	3	32	Impact of new nuclear data on the design of transmutation experiments	CNRS
8	4	38	Impact of new results on the design of the spallation target and the subcritical blanket	CIRTEN
9	4	42	Impact of new results on accelerator - reactor coupling	TUD
10	4	46	Impact of new data on fuels for ADS	KTH/UU

External Training Activities

- **Status Workshops,**
- **Direct link between P&T, Generation IV and geological disposal,**
- **Frederic Joliot – Otto Hahn Summer School 2007 at FZK: “Sustainability of Nuclear Energy: Generation IV, Partitioning & Transmutation, Waste Management”.**



Frédéric Joliot/Otto Hahn

**THE 2007 FREDERIC JOLIOT & OTTO HAHN
SUMMER SCHOOL ON NUCLEAR REACTORS
“ PHYSICS, FUELS, AND SYSTEMS “**

jointly organized by the “Commissariat à l’Energie Atomique” (France)
and the “Forschungszentrum Karlsruhe” (Germany)

**Sustainability of Nuclear Energy :
Gen-IV, Partitioning & Transmutation, Waste Management**



Forschungszentrum Karlsruhe

**Forschungszentrum Karlsruhe, Germany
August 29 – September 7, 2007**



Conclusions

- **The strategic outcome of EUROTRANS is expected to provide a state-of-the-art, reliable basis for the assessment of the technical feasibility of transmutation by ADS and a first estimate of the cost of an ADS based transmutation system.**
- **It is also expected to provide important input elements to authorities to decide whether to embark on the detailed engineering design of an ADS for transmutation (being the XT-ADS) and its eventual construction after completion of this project.**
- **Provide input to:**
 - **P&T Roadmap Activity: PATEROS**
 - **Sustainable Nuclear Fission Technology Platform: SNF-TP**
- **EUROTRANS includes 30 partners from 17 countries (10 industries, 19 research centres, ENEN represents 14 universities); links to Belarussian, Russian, US, Japanese research institutions.**
- **Education and Training Activities are a major issue of EUROTRANS.**

EUROTRANS

EUROPEAN RESEARCH PROGRAMME FOR THE TRANSMUTATION OF HIGH LEVEL NUCLEAR WASTE IN AN ACCELERATOR DRIVEN SYSTEM

Thank you.

