

**EXPERIENCE AND EVALUATION OF ADVANCED ON-LINE
CORE MONITORING SYSTEM "BEACON" AT IKATA SITE**

**Nobumichi Fujitsuka, Hideyuki Tanouchi,
Yasuhiro Imamura, Daisuke Mizobuchi**

IKATA Power Station
Shikoku Electric Power Co., Inc.
Ikata-Cho, Nishiuwa-Gun, Ehime, 796-04, Japan
Tel: +81-894-39-0221, Fax: +81-894-39-0686

Takashi Kanagawa, Masahiro Masuda

Mitsubishi Heavy Industries, Ltd.
3-3-1, Minatomirai, Nishi-Ku, Yokohama, 220-84, Japan
Tel: +81-45-224-9622, Fax: +81-45-224-9971
E-mail: kanagawa@atom.hq.mhi.co.jp

Abstract

Shikoku Electric Power Company installed BEACON core monitoring system into IKATA unit 3 in May 1994. During its 1st cycle of core operation, various operational data were obtained including data of some anomalous reactor conditions introduced for the test objective of the plant start-up. This paper presents the evaluation of the BEACON system capability based on this experience. The system functions such as core monitoring and anomaly detection, prediction of future reactor conditions and increased efficiency of core management activities are discussed. Our future plan to utilise the system is also presented.

Introduction

Accurate and detailed information of core condition is indispensable in order to make the best use of core and fuel capability and also to achieve flexible and efficient operation. From this point of view, "BEACON", an advanced on-line core monitoring system for PWRs, has been developed by Westinghouse Electric Corporation, and has accumulated experiences in helping core operation and management at about twenty PWR plants [1-3].

The BEACON system is an operation support package which consists of computer software and plant operation procedures such as technical specification and operation instructions. The BEACON software runs on a desk top workstation with a data link to the plant computer. Using standard computer network capabilities, the system output and input displays can be seen and used at any workstation or X-terminal in the established network. Together with this package system, BEACON enables flexible and efficient plant operation, early stage anomaly detection, and helps core management activities.

This paper evaluates operational experience of the BEACON system at IKATA unit 3, a 3 loop PWR plant which started commercial operation in December 1994. Shikoku Electric Power Company installed the BEACON system into IKATA unit 3 in May 1994. Though the plant has been operated under the conventional technical specification (independent from BEACON), various operational data during the first cycle of core operation has been obtained including data of some anomalous reactor conditions during the plant start-up tests, which are difficult to obtain during normal operation.

Based on this experience, the BEACON system capabilities are also discussed and evaluated in this paper for such functions as core monitoring and anomaly detection, accurate core predictions and increased efficiency of core management activities.

System overview

BEACON system functions

The BEACON system uses data from ex-core neutron detectors, core exit thermocouples, periodic in-core movable detectors and plant process data together with a three-dimensional nodal simulator to yield a continuously measured three-dimensional power distribution. Based on this continuous power distribution measurement, BEACON performs variety of core support functions as shown in Figure 1.

The major functions and objectives of the current BEACON system are:

- On-line direct monitoring function of power distribution and related parameters, which gives operation flexibility and anomaly detection capability at early stages.
- Advanced 3D nodal prediction function for core behaviour, which enables efficient plant operation planning and core control.
- Core examination and data evaluation functions, which support and integrate fuel/core management activities and reduce required manpower.
- Well designed graphic user interface (GUI) collaborating with all BEACON functions, which helps site engineers analysing and evaluating core conditions, and increase engineering productivity.

Figure 1. BEACON system functions

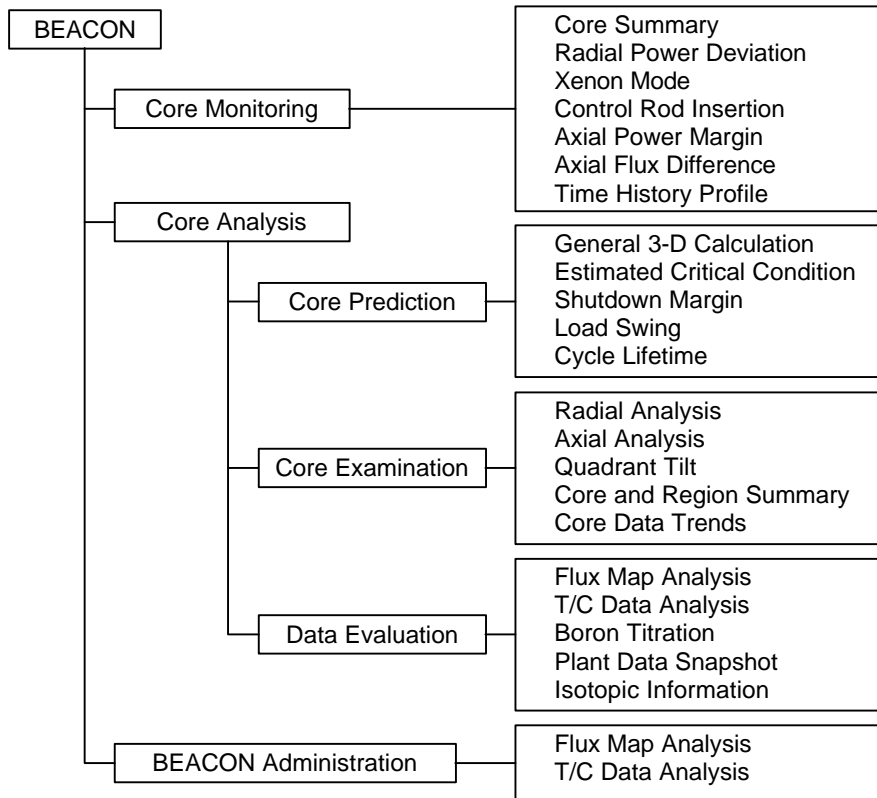
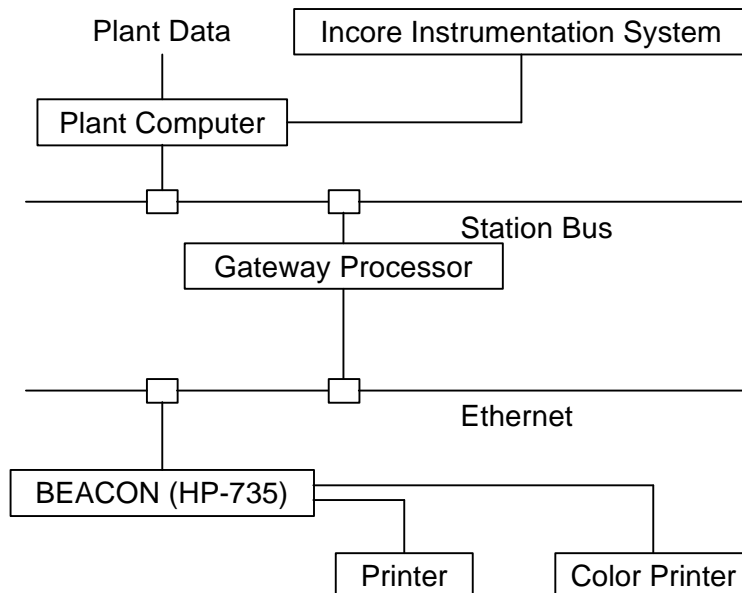

Figure 2. BEACON hardware configuration at IKATA-3



System configuration

Figure 2 shows the BEACON system hardware configuration at IKATA unit 3. The system consists of a desk top workstation (HP-735) and printers. They are settled in the next room to the central control room to allow both operators and core engineers to use the system.

The system has a data link to the plant computer via a gateway processor, and acquires all required data from it including in-core flux trace data.

The BEACON system software consists of a set of independent software processes. All user actions and system responses are processed through a powerful graphic user interface. This interface helps users not only to operate easily but also to understand data trend quickly.

Core monitoring and anomaly detection

In order to evaluate BEACON core monitoring function, accuracy of monitored power distribution under normal plant operation and core anomaly detection capability should be verified. In this section, we present our experience and evaluation of anomaly detection.

As parts of PWR start-up tests, physics tests simulating anomalous core conditions such as control rods misalignment etc. are performed from the safety point of view. From the BEACON core monitoring displays and data edits during these tests at IKATA unit 3, we verified that BEACON is capable of detecting early stages of core anomalies before it reaches Technical Specification limitation as follows:

- Control rods misalignment was detected from the change of the local colours of the core figure on the graphic monitoring display. The colour of each fuel assembly on the graphical display indicates deviation from the expected power distribution, and changes according to core exit thermocouple signal deviation from the expected value.

Figure 3 shows some monitoring display examples on which the local colours changed during the pseudo rod drop test. During this test, one RCC at E-11 location was inserted with the Bank-D at 220 steps, and reactor power was kept constant at about 50% of rated thermal power. The effect of rod misalignment was detected on the display when E-11 RCC inserted to around 190 steps.

On the other hand, during the pseudo rod ejection test, one Bank-D RCC at B-8 location was withdrawn with the Bank-D at 187 steps. During this test, the effect of the rod misalignment was detected on the display when B-8 RCC was withdrawn to around 205 steps.

For both these cases, relatively large misalignments were required to be detected because the RCC reactivity worth at the top of the core was very small at the beginning of the first cycle core. Simulation results show that the inserted or withdrawn RCC reactivity was less than 10 pcm, and the fuel assembly power changed about 5% (relative) at the manoeuvred RCC position and about 3% at the surrounding thermocouple locations when the misalignments were detected.

Figure 3. Monitoring display under rod misalignment condition

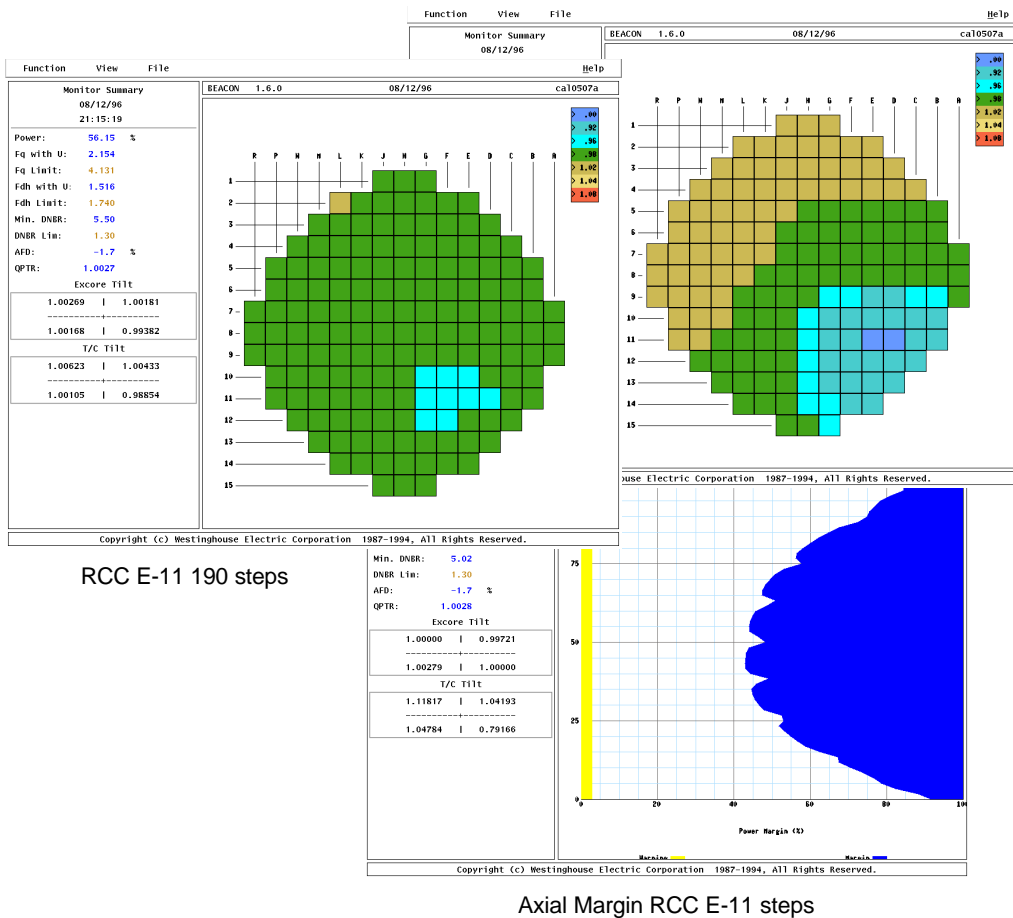

For typical reload cores, the same effect will appear with around 10 steps misalignment from a typical operational rod configuration (Bank D around 210 steps).

From these results, we estimated that a rod misalignment from a typical bank position can be detected before the extent of the misalignment reaches about a half of its Technical Specification limitation (i.e. 12 steps) for reload cores.

- During and after these tests, quadrant power tilt was detected before it reached its Technical Specification limitation from changing colours on the graphic monitoring display. The radial xenon oscillation was also followed continuously from the graphic and digital monitoring display.
- Axial xenon oscillations was detected and followed, and useful control guidance for oscillation control was also obtained from graphic xenon mode display. This provided visual information on what stage the oscillation was in and when to initiate control action to dampen the oscillation.
- Axial margin display shown in Figure 3 continuously provided plant operators with actual F_Q and DNBR margin against the limitations, which was the smaller.

Core analysis

Figure 4. Prediction result for load reduction and re-start-up

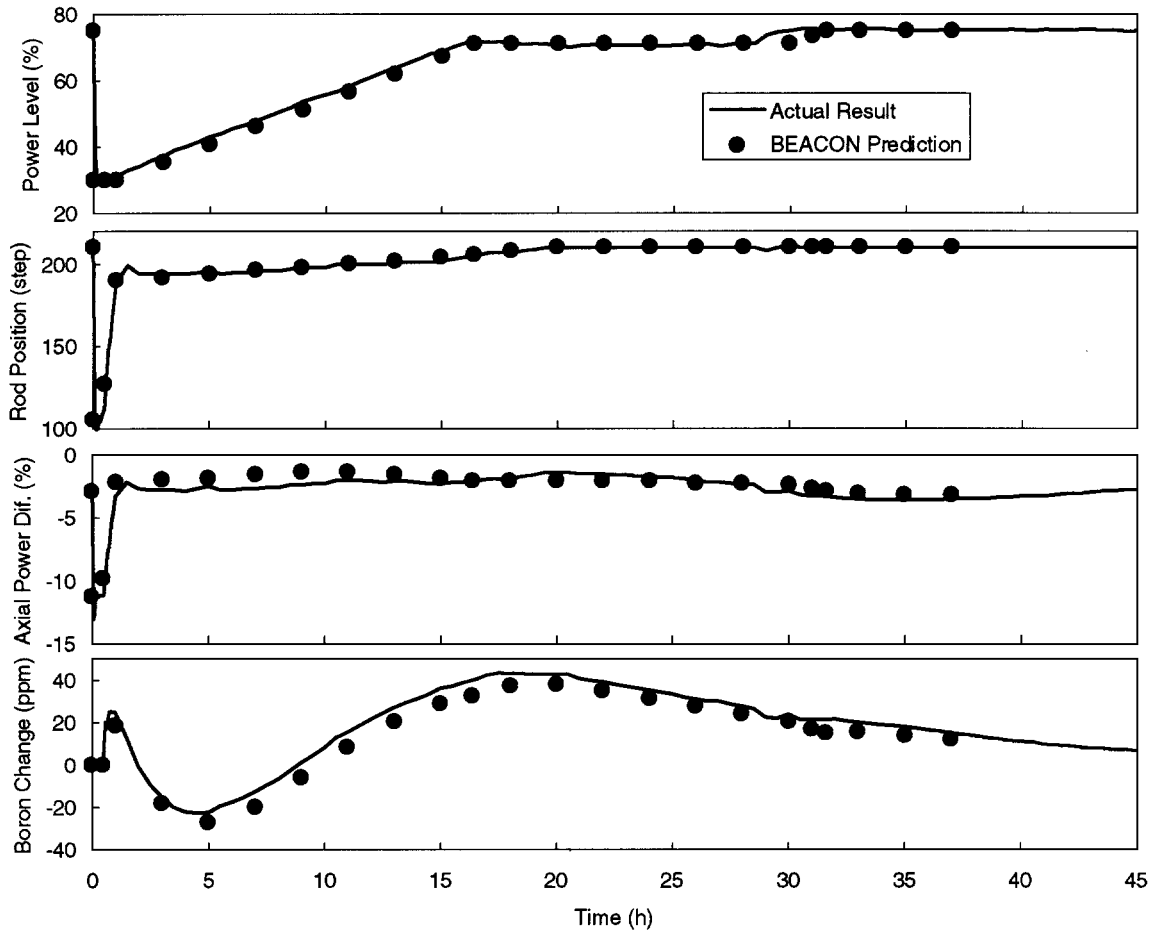

BEACON has several core analysis functions which support core management activities. Through our experience, we verified its prediction and flux map processing capability, and evaluated the effect on increasing efficiency of core management activities.

Core prediction

We verified the accuracy of BEACON predictions through various physics tests and plant normal operation. These tests included power manoeuvring and control rods movement.

BEACON utilises 1D and 3D simulation capability for core predictions and has several special prediction menu as shown in Figure 1 to make frequent prediction calculation be easy. Here we show some prediction results for short term power manoeuvring and core life time.

Figure 4 shows comparison of parameters of BEACON prediction with actual core parameters during load reduction test and following re-start-up. During this test, the electric

load was reduced from 75% to 25% of rated power at once, and then recovered to 75% at the rate of 3%/h. Figure 5 shows another comparison during power coefficient measurement test. During this test, the electrical load was reduced from 75% to 50% at the rate of 1%/min and held constant at every 5% reduction. Soluble boron concentration was kept constant.

Figure 5. Prediction result for power coefficient measurement test

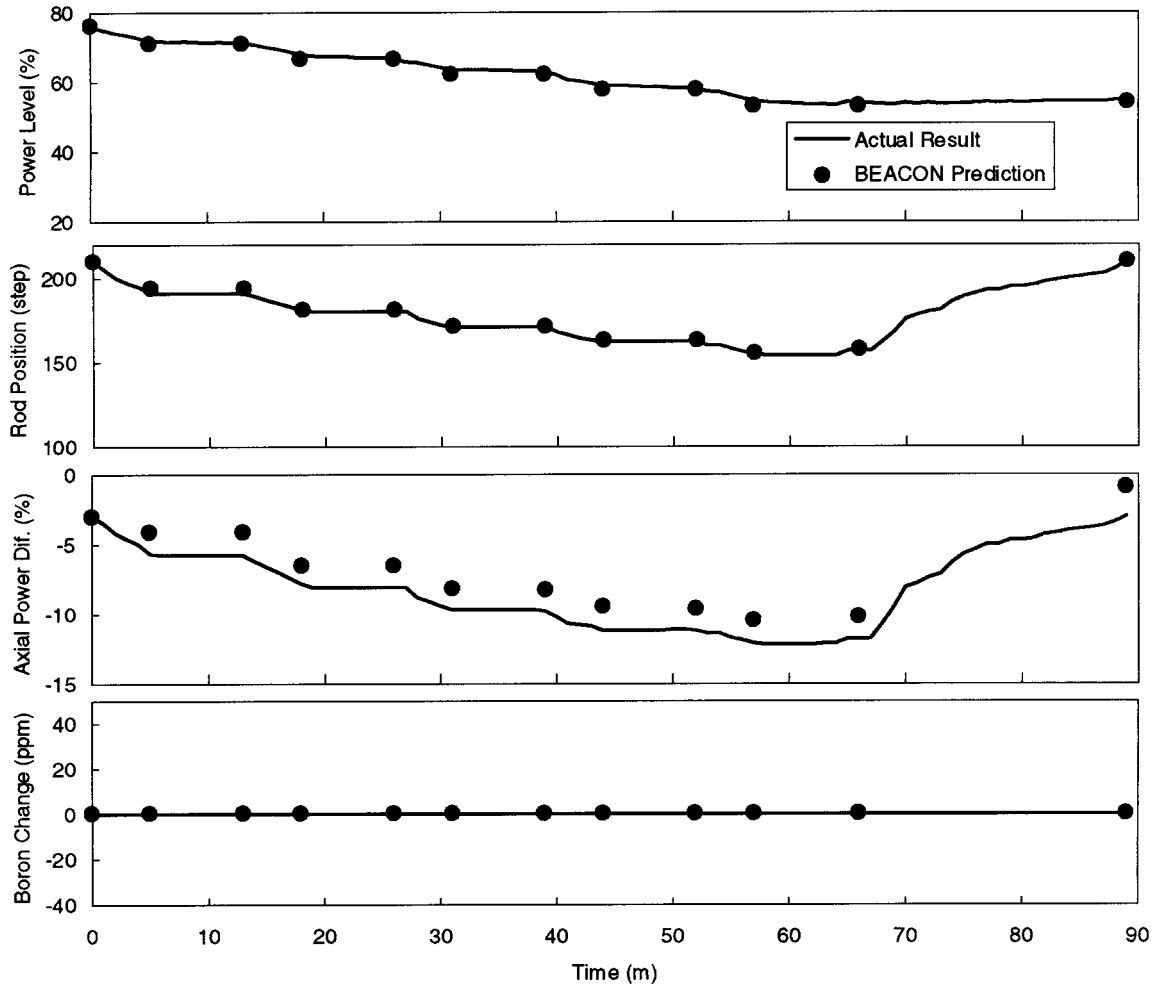

Though these tests included large variation of power level, xenon, and other parameters, predictions agreed well with actual results as shown in Figure 4 and Figure 5. The prediction error was less than 7 ppm for boron concentration change, less than three steps for more than 50 steps movement, and less than 2% for axial power difference.

Figure 6 shows the result of core life time prediction calculated from the beginning of the core. Through the 1st cycle, the boron concentration differences between BEACON prediction and the actual results were less than 20 ppm (equivalent with 6 days).

These results indicate that BEACON prediction of control rod movement and soluble boron concentration change can be accurate enough for example, for planning plant re-start-ups, planning plant operation cycle etc. As for axial power difference or its oscillation,

predictions were also accurate enough at the beginning of the 1st cycle of which xenon oscillation characteristics is convergent, and we also need to confirm it for cores with divergent xenon oscillation characteristics.

At IKATA site, we also need to predict plant re-start-up every month to inform plant operators. BEACON has shown that it can increase efficiency of such routine work by its fast calculation and powerful GUI which enables site engineers to set up input parameters easily and to understand the result quickly.

Figure 6. Prediction results for core life time

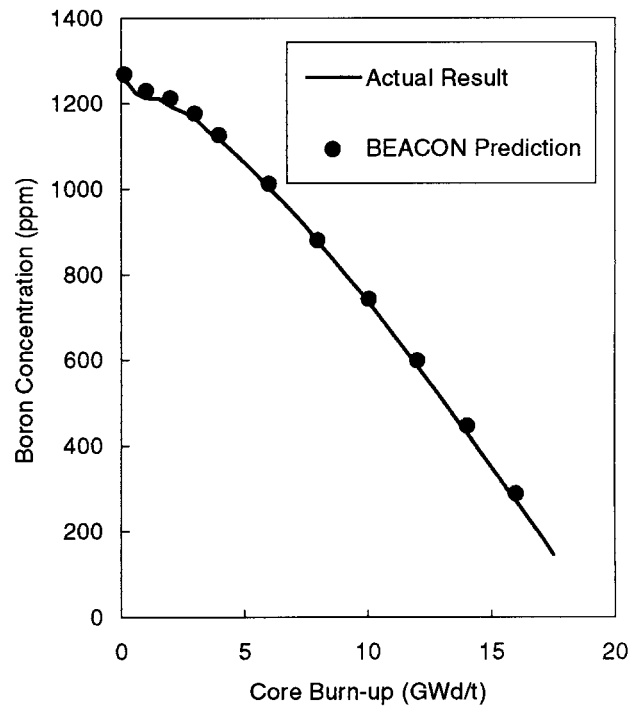

Core examination and data evaluation

In addition to core prediction capability, BEACON system has several analysis capabilities which support and integrate fuel and core management activities for power distribution, assembly burn-up, isotope inventories, core reactivity etc. These capabilities are shown as “Core Examination” and “Data Evaluation” in Figure 1.

Though the core monitoring function provides plant operators with the current core condition continuously and clearly, the core examination capability allows site engineers to analyse a core nodal model in detail from a variety of perspectives. Examinations are available not only for the current or other previous core states but also for any prediction results.

At IKATA site, we utilised this capability mainly to examine the monitored core condition periodically. Graphically provided information like Figure 7 were helpful to examine and understand actual core condition.

Figure 7. A sample of core examination display

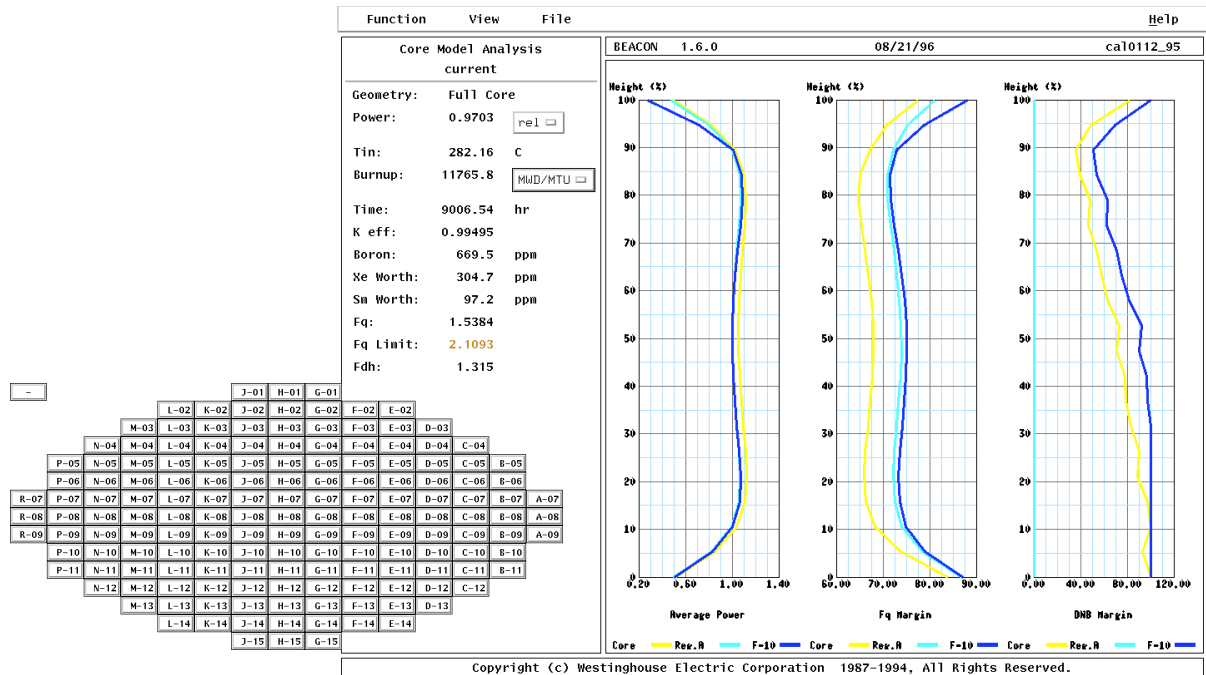

Axial profiles of power, Fq margin and DNBR margin for core average and specified assembly

Among the data evaluation capabilities, in-core flux map processing and its analysis are the basis of fuel and core management. We verified the following advantages given by BEACON flux map function;

- We verified that the results of BEACON flux map processing gave consistent power distributions with the results of conventional off-line processing. Figure 8 shows an example of processed assembly power differences. Power distributions were not perfectly identical due to the processing methodology difference and the reference power distribution difference. Taking into account of these differences, both result were consistent enough for the practical use.

Figure 8. Differences of flux map processing results

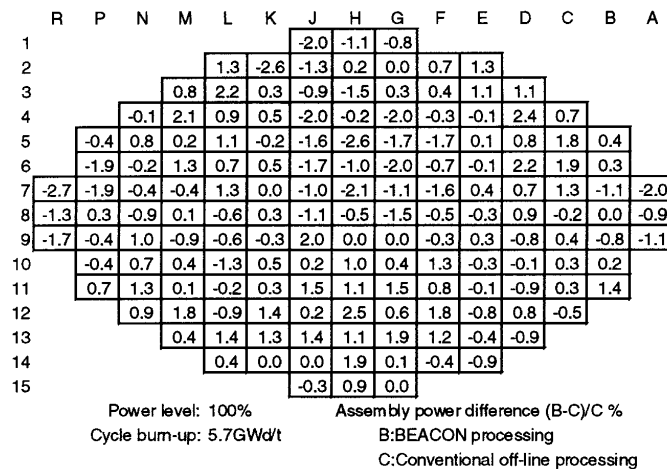

- Time required for map processing after flux trace data acquisition was greatly reduced in comparison with conventional method as shown in Table 1. This advantage is mainly due to the fact that the system has all required data and combines them automatically for processing calculation.

Table 1. Reduction of map processing time (minutes)

	Data Transfer	Input Setting	Processing	Output	Total
BEACON	2	1	<1	<1	<5
Conventional	15	15	15	15	60

- BEACON graphic analysis support functions were helpful for analysing processed results. It increased analysis efficiency and reduced time to examine the results.

Future plan

Currently, we have still been accumulating our experience and applying BEACON system for our core management activities such as core prediction, core examination, etc. After a few cycles operation, we will integrate most of our core management activities into the system and increase the efficiency of them.

We will continue enhancing BEACON functions further and utilise BEACON for increasing operation efficiency in such areas as reducing start-up time by eliminating in-core/ex-core detector calibration test and performing flux mapping under transient xenon conditions.

We also consider that such on-line monitoring system provides its best advantage when a plant is operated by monitoring and limiting key safety parameters like linear heat rate and DNBR directly. To realise such operation, the relationship between operation and safety analysis should be re-constructed. We are going to start basic study on it.

Conclusion

The results from the IKATA unit 3 cycle 1 test show that the BEACON system can provide accurate information on the current core conditions and the predicted future conditions. With proper integration into the core management procedures and processes, this can be used to increase the efficiency of those activities.

We will continue enhancing BEACON functions further and utilise BEACON for integrating core management activities and for increasing operation efficiency, for example, reducing start-up time by eliminating in-core/ex-core detector calibration test and performing flux mapping under transient xenon conditions.

REFERENCES

- [1] C.L. Beard and T. Morita, "The BEACON Core Monitoring System," *Trans Am. Nuc. Soc.* (56), pp. 518-519 (1988).
- [2] C.L. Beard, "Experience with the BEACON Core Monitoring System," OECD Specialists' Meeting on In-core Instrumentation and Reactor Core Assessment, Pittsburgh, PA, 1-4 October 1991.
- [3] R.J. Buechel and W.A. Boyd, "The Westinghouse BEACON On-line Core Monitoring System," XENFIR, Aguas de Lindoia, Brazil, pp. 422-426 (1995).